

NEW ITEMS

Regent 5" Casters

Page 7



Regent Rigid Casters

Page 7



Expanding Adapter Stem
Regent & Institutional

Page 7 & 22



Omega Casters

Page 21



Institutional Threaded
Stem Casters

Page 22 & 66



Top Lock Brake for
Institutional Series

Page 22



Source II Unhooded

Page 37



Grey SofTech Casters

Page 48



5" x 1" MonoTech Wheels

Page 64



Institutional TPR Wheels
With Nylon Bearings

Page 66



TABLE OF CONTENTS

Wheel Casters

Regent 7
 Monarch 15
 Baron 19
 Omega 21

Institutional

Institutional 22

Dolly Casters

Dolly Caster 27

General Duty

General Duty 28

Twin Wheel Casters

DIE-CAST TWIN WHEELS

Pacer 30
 Pilot 34

NYLON TWIN WHEELS

Source II 36
 Source II Unhooded 37
 Pert 39
 Replacement Chair Casters 41
 Innovator 42
 Prim 44
 Heavy Duty 45
 Euro-Ultima 45

Large Twin Wheel Casters

Ultima II 46
 SofTech 48
 Travelaid 50
 Total Lock 52

Ball Casters

Metal Tread 53
 Soft Tread 57
 Profile 62

Wheels

Wheels 64

Sockets, Glides, & Accessories

Sockets, Glides, & Accessories 67

Fastenings

Fastenings 70

CASTER SELECTION

Caster Terms and Ratings

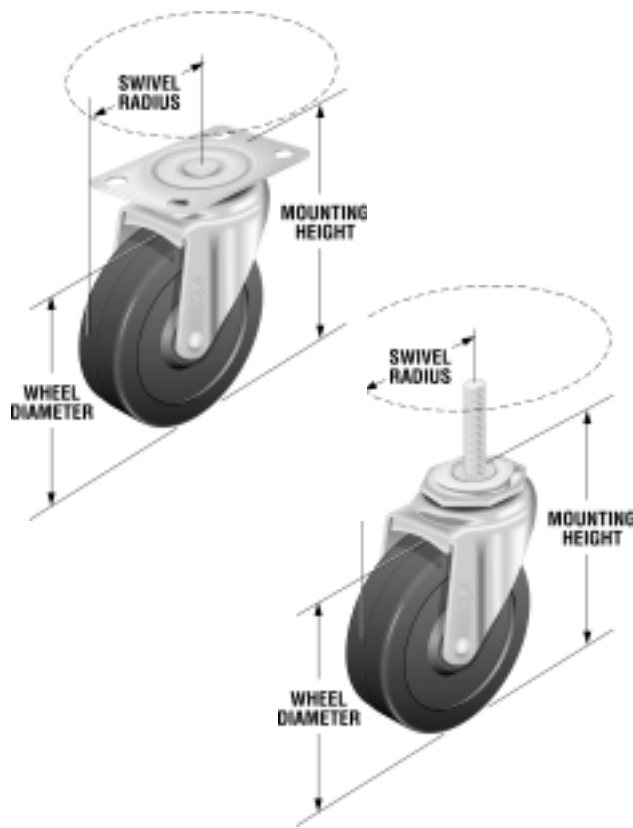

Swivel Radius – The distance from the center of the fastening to the outer most point of the caster. This specifies the minimum clearance required for a mounted caster to swivel 360 degrees.

Wheel Diameter – The outside diameter of the wheel. (Larger diameter wheels tend to roll easier and be more shock absorbing than smaller diameter wheels.)

Mounting Height – The vertical distance between the floor and the mounting point of the unit.

Dynamic Load – The load a caster is designed to carry on a continuous basis. Load is assigned on a per caster basis. To determine the load based on the number of casters on the unit, divide the total weight by the number of casters.

For example: a chair needs to support 300 pounds and will use 5 casters.

$$\frac{300 \text{ pounds}}{5 \text{ casters}} = 60 \text{ lb. load rating required}$$

The following examples illustrate the sequence in which number and letter codes are combined to specify a particular caster. Each standard part number is included in the caster specification charts throughout the catalog.

WHEEL CASTER PRE3025ZN-3EB					
Caster Code	Wheel Diameter	Fastening	Finish	Tread Material	Option
PRE	30	25	ZN	-3E	B
Regent	3"	#25 Threaded	Zinc	Black Polyolefin	Brake

INSTITUTIONAL CASTER PGS40120ZN-TPR22(GG)TB								
Caster Code	Wheel Dia.	Fastening	Finish	Tread Material	Bearing Type	Thread Guard	Wheel Color	Options
PGS	40	120	ZN	-TPR	2	2	(GG)	TB
Institutional Swivel	4"	#120 Top Plate	Zinc	Thermoplastic Rubber	Ball	Partial Wheel Thread Guard	Grey Tread & Core	Tread Brake

TWIN WHEEL CASTER PPA6002BC-U				
Caster Code	Wheel Diameter	Fastening	Finish	Option
PPA	60	02	BC	-U
Pacer	60 mm	#02 Grip Neck	Bright Chrome	Urethane

BALL CASTER PPL2588BB-B				
Caster Code	Wheel Diameter	Fastening	Finish	Option
PPL	25	88	BB	-B
Planet	2½"	#88 Grip Ring	Bright Brass	Brake

Tread Material

Use the following chart as a guide for choosing a tread material that's right for your floor.

		TREAD						
		Urethane	Hard Rubber	Soft Rubber	Polyolefin	TPR ¹	TPU ²	MonoTech
FLOORING	Carpeting	F	E	NR	E	F	F	F
	Wood	E	NR	F	NR	E	E	E
	Tile	E	NR	F	NR	E	E	E
	Terrazzo	E	NR	F	NR	E	E	E
	Linoleum	E	NR	F	NR	E	E	E
	Concrete	E	E	E	E	E	E	E

E = Excellent F = Fair NR = Not Recommended

¹Thermoplastic Rubber

²Thermoplastic Polyurethane

REGENT

Single Wheel Casters 1 5/8", 2", 2 1/2", 3", 4", 5"



STANDARD FEATURES

- Zinc finish
- Double ball bearing raceways
- Octagon washer on threaded stem models
- Heat Treated
- Meets or exceeds ANSI/BIFMA and ICM standards for the caster industry
- All Regent Series casters without thread guards are NSF approved



APPLICATIONS

- Fixtures
- Carts
- Institutional Equipment
- Medical Equipment
- Furniture

OPTIONS

OTHER FINISHES

Black Oxide [BO], Copper Oxide [CO], Polished Nickel [PN]

Insert finish code for [ZN] in Part Number. Minimum order quantities may apply.

EXPANDING ADAPTER STEMS

Consult factory for part numbers and pricing.



OTHER FASTENINGS

Other fastenings available. Consult factory.

FRICTION BRAKE

Available on 2", 2 1/2", and 3" models only. Insert [-B] at the end of the part number.



TREAD LOCK BRAKE

Available on 4" and 5" models. Insert [-B] at the end of the part #.



THREADED STEM WASHER WRENCH

Use to hold caster in place while assembling to unit. To order use Part Number [Wrench RE GS GT ZN].



WHEEL SELECTIONS



SOFT [-R]* AND HARD [-H] RUBBER

POLYOLEFIN [-E]

POLYURETHANE [-TPU]

THERMOPLASTIC RUBBER [-TPR]



GRAY MONOTECH [-MNT]



5" GRAY MONOTECH With Optional Precision Bearing & Thread Guards Insert -MNT33(GG) after finish code



2" SOLID POLYURETHANE [-3ES]

*Soft Rubber Conductive Tread available. Minimum order quantity may apply.



Wheel Diameter	Fastening Size	Tread Material	Tread Width	Dynamic Load	Mounting Height	Swivel Radius	Part Number
1 5/8"	5/16"-18 x 3/4" #32	Polyolefin Soft Rubber	11/16"	75 lb. 70 lb.	2 5/16"	1 5/8"	PRE1632ZN-3E PRE1632ZN-3R
	5/16"-18 x 1" #07	Polyolefin Soft Rubber	11/16"	75 lb. 70 lb.			PRE1607ZN-3E PRE1607ZN-3R
	3/8"-16 x 1 1/2" #05	Polyolefin Soft Rubber	11/16"	75 lb. 70 lb.			PRE1605ZN-3E PRE1605ZN-3R
2"	5/16"-18 x 3/4" #32	Polyolefin Soft Rubber	3/4"	90 lb.	2 5/8"	1 15/16" 2 1/4" [-B]	PRE2032ZN-3E PRE2032ZN-3R
		Hard Rubber TPR	13/16"	80 lb.			PRE2032ZN-3H PRE2032ZN-TPR PRE2032ZN-TPU
	5/16"-18 x 1" #07	Polyolefin Soft Rubber	3/4"	90 lb.			PRE2007ZN-3E PRE2007ZN-3R
		Hard Rubber TPR	13/16"	80 lb.			PRE2007ZN-3H PRE2007ZN-TPR PRE2007ZN-TPU
	5/16"-18 x 1 1/2" #500	Polyolefin Soft Rubber	3/4"	90 lb.			PRE20500ZN-3E PRE20500ZN-3R
		Hard Rubber TPR	13/16"	80 lb.			PRE20500ZN-3H PRE20500ZN-TPR PRE20500ZN-TPU
	3/8"-16 x 3/4" #37	Polyolefin Soft Rubber	3/4"	90 lb.			PRE2037ZN-3E PRE2037ZN-3R
		Hard Rubber TPR	13/16"	80 lb.			PRE2037ZN-3H PRE2037ZN-TPR PRE2037ZN-TPU
	3/8"-16 x 1" #34	Polyolefin Soft Rubber	3/4"	90 lb.			PRE2034ZN-3E PRE2034ZN-3R
		Hard Rubber TPR	13/16"	80 lb.			PRE2034ZN-3H PRE2034ZN-TPR PRE2034ZN-TPU
	3/8"-16 x 1 1/2" #05	Polyolefin Soft Rubber	3/4"	90 lb.			PRE2005ZN-3E PRE2005ZN-3R
		Hard Rubber TPR	13/16"	80 lb.			PRE2005ZN-3H PRE2005ZN-TPR PRE2005ZN-TPU
1/2"-13 x 1 1/2" #48	Polyolefin Soft Rubber	3/4"	90 lb.	PRE2048ZN-3E* PRE2048ZN-3R*			
	Hard Rubber TPR	13/16"	80 lb.	PRE2048ZN-3H* PRE2048ZN-TPR* PRE2048ZN-TPU*			
2 1/2" Continues on next page	5/16"-18 x 3/4" #32	Polyolefin Soft Rubber	13/16"	95 lb.	3 1/8"	2 1/8" 2 1/4" [-B]	PRE2532ZN-3E PRE2532ZN-3R
		Hard Rubber TPR		80 lb.			PRE2532ZN-3H PRE2532ZN-TPR PRE2532ZN-TPU
	5/16"-18 x 1" #07	Polyolefin Soft Rubber	13/16"	95 lb.			PRE2507ZN-3E PRE2507ZN-3R
5/16"-18 x 1 1/2" #500	Polyolefin Soft Rubber	13/16"	80 lb.	PRE2507ZN-3H PRE2507ZN-TPR PRE2507ZN-TPU			
	Hard Rubber TPR		95 lb.	PRE25500ZN-3E PRE25500ZN-3R			
				80 lb.			PRE25500ZN-3H PRE25500ZN-TPR PRE25500ZN-TPU

* Minimum order quantities may apply.

Dimensions shown are approximate. Contact factory for specific dimensions.
Other fastenings and finishes may be available. Order restrictions may apply.

Wheel Diameter	Fastening Size	Tread Material	Tread Width	Dynamic Load	Mounting Height	Swivel Radius	Part Number
2 1/2" Continued from previous page	3/8"-16 x 3/4" #37	Polyolefin Soft Rubber Hard Rubber TPR Polyurethane	13/16"	95 lb. 80 lb. 95 lb. 80 lb. 95 lb.	3 1/8"	2 1/8" 2 1/4" [-B]	PRE2537ZN-3E PRE2537ZN-3R PRE2537ZN-3H PRE2537ZN-TPR PRE2537ZN-TPU
	3/8"-16 x 1" #34	Polyolefin Soft Rubber Hard Rubber TPR Polyurethane	13/16"	95 lb. 80 lb. 95 lb. 80 lb. 95 lb.			PRE2534ZN-3E PRE2534ZN-3R PRE2534ZN-3H PRE2534ZN-TPR PRE2534ZN-TPU
	3/8"-16 x 1 1/2" #05	Polyolefin Soft Rubber Hard Rubber TPR Polyurethane	13/16"	95 lb. 80 lb. 95 lb. 80 lb. 95 lb.			PRE2505ZN-3E PRE2505ZN-3R PRE2505ZN-3H PRE2505ZN-TPR PRE2505ZN-TPU
	1/2"-13 x 1 1/2" #48	Polyolefin Soft Rubber Hard Rubber TPR Polyurethane	13/16"	95 lb. 80 lb. 95 lb. 80 lb. 95 lb.			PRE2548ZN-3E* PRE2548ZN-3R* PRE2548ZN-3H* PRE2548ZN-TPR* PRE2548ZN-TPU*
3"	5/16"-18 x 3/4" #32	Polyolefin Soft Rubber Hard Rubber TPR Polyurethane Monotech	13/16"	120 lb. 110 lb. 120 lb. 110 lb. 120 lb. 120 lb.	3 1/2"	2 3/8" 2 3/8" [-B]	PRE3032ZN-3E PRE3032ZN-3R PRE3032ZN-3H PRE3032ZN-TPR PRE3032ZN-TPU PRE3032ZN-MNT
	5/16"-18 x 1" #07	Polyolefin Soft Rubber Hard Rubber TPR Polyurethane Monotech	13/16"	120 lb. 110 lb. 120 lb. 110 lb. 120 lb. 120 lb.			PRE3007ZN-3E PRE3007ZN-3R PRE3007ZN-3H PRE3007ZN-TPR PRE3007ZN-TPU PRE3007ZN-MNT
	5/16"-18 x 1 1/2" #500	Polyolefin Soft Rubber Hard Rubber TPR Polyurethane Monotech	13/16"	120 lb. 110 lb. 120 lb. 110 lb. 120 lb. 120 lb.			PRE30500ZN-3E PRE30500ZN-3R PRE30500ZN-3H PRE30500ZN-TPR PRE30500ZN-TPU PRE30500ZN-MNT
	3/8"-16 x 3/4" #37	Polyolefin Soft Rubber Hard Rubber TPR Polyurethane Monotech	13/16"	120 lb. 110 lb. 120 lb. 110 lb. 120 lb. 120 lb.			PRE3037ZN-3E PRE3037ZN-3R PRE3037ZN-3H PRE3037ZN-TPR PRE3037ZN-TPU PRE3037ZN-MNT
	3/8"-16 x 1" #34	Polyolefin Soft Rubber Hard Rubber TPR Polyurethane Monotech	13/16"	120 lb. 110 lb. 120 lb. 110 lb. 120 lb. 120 lb.			PRE3034ZN-3E PRE3034ZN-3R PRE3034ZN-3H PRE3034ZN-TPR PRE3034ZN-TPU PRE3034ZN-MNT
	3/8"-16 x 1 1/2" #05	Polyolefin Soft Rubber Hard Rubber TPR Polyurethane Monotech	13/16"	120 lb. 110 lb. 120 lb. 110 lb. 120 lb. 120 lb.			PRE3005ZN-3E PRE3005ZN-3R PRE3005ZN-3H PRE3005ZN-TPR PRE3005ZN-TPU PRE3005ZN-MNT
	1/2"-13 x 1 1/2" #48	Polyolefin Soft Rubber Hard Rubber TPR Polyurethane Monotech	13/16"	120 lb. 110 lb. 120 lb. 110 lb. 120 lb. 120 lb.			PRE3048ZN-3E* PRE3048ZN-3R* PRE3048ZN-3H* PRE3048ZN-TPR* PRE3048ZN-TPU* PRE3048ZN-MNT*

* Minimum order quantities may apply.

Dimensions shown are approximate. Contact factory for specific dimensions.
Other fastenings and finishes may be available. Order restrictions may apply.

REGENT

Threaded Stems



WHEEL CASTERS

Wheel Diameter	Fastening Size	Tread Material	Tread Width	Dynamic Load	Mounting Height	Swivel Radius	Part Number
4"	3/8"-16 x 1 1/2" #05	Polyolefin	15/16"	150 lb.	4 3/4"	3 5/16" 3 7/16" [-B]	PRE4005ZN-3E
		Soft Rubber		125 lb.			PRE4005ZN-3R
	Hard Rubber	150 lb.	PRE4005ZN-3H				
	TPR	125 lb.	PRE4005ZN-TPR				
	Polyurethane	150 lb.	PRE4005ZN-TPU				
7/16"-14 x 1 1/2" #800	Polyolefin	15/16"	150 lb.	PRE40800ZN-3E			
	Soft Rubber		125 lb.	PRE40800ZN-3R			
7/16"-14 x 2 1/4" #806	Hard Rubber	15/16"	150 lb.	PRE40800ZN-3H			
	TPR		125 lb.	PRE40800ZN-TPR			
1/2"-13 x 1" #41	Polyurethane	15/16"	150 lb.	PRE40800ZN-TPU			
	Monotech		150 lb.	PRE40800ZN-MNT			
1/2"-13 x 1 1/2" #48	Polyolefin	15/16"	150 lb.	PRE40806ZN-3E			
	Soft Rubber		125 lb.	PRE40806ZN-3R			
1/2"-13 x 1" #41	Hard Rubber	15/16"	150 lb.	PRE40806ZN-3H			
	TPR		125 lb.	PRE40806ZN-TPR			
1/2"-13 x 1 1/2" #48	Polyurethane	15/16"	150 lb.	PRE40806ZN-TPU			
	Monotech		150 lb.	PRE40806ZN-MNT			
5"	3/8"-16 x 1 1/2" #05	Polyolefin	15/16"	150 lb.	5 3/4"	4 1/8" 4 1/8" [-B]	PRE5005ZN-3E
		Soft Rubber		130 lb.			PRE5005ZN-3R
	Hard Rubber	150 lb.	PRE5005ZN-3H				
	TPR	130 lb.	PRE5005ZN-TPR				
	Polyurethane	150 lb.	PRE5005ZN-TPU				
7/16"-14 x 1 1/2" #800	Monotech	15/16"	160 lb.	PRE5005ZN-MNT			
	Polyolefin		15/16"	150 lb.	PRE50800ZN-3E		
Soft Rubber	130 lb.	PRE50800ZN-3R					
7/16"-14 x 2 1/4" #806	Hard Rubber	15/16"	150 lb.	PRE50800ZN-3H			
	TPR		130 lb.	PRE50800ZN-TPR			
1/2"-13 x 1" #41	Polyurethane	15/16"	130 lb.	PRE50800ZN-TPU			
	Monotech		160 lb.	PRE50800ZN-MNT			
1/2"-13 x 1 1/2" #48	Polyolefin	15/16"	150 lb.	PRE50806ZN-3E			
	Soft Rubber		130 lb.	PRE50806ZN-3R			
1/2"-13 x 1" #41	Hard Rubber	15/16"	150 lb.	PRE50806ZN-3H			
	TPR		130 lb.	PRE50806ZN-TPR			
1/2"-13 x 1 1/2" #48	Polyurethane	15/16"	150 lb.	PRE50806ZN-TPU			
	Monotech		160 lb.	PRE50806ZN-MNT			
1/2"-13 x 1" #41	Polyolefin	15/16"	150 lb.	PRE5041ZN-3E			
	Soft Rubber		130 lb.	PRE5041ZN-3R			
1/2"-13 x 1 1/2" #48	Hard Rubber	15/16"	150 lb.	PRE5041ZN-3H			
	TPR		130 lb.	PRE5041ZN-TPR			
1/2"-13 x 1" #41	Polyurethane	15/16"	150 lb.	PRE5041ZN-TPU			
	Monotech		160 lb.	PRE5041ZN-MNT			
1/2"-13 x 1 1/2" #48	Polyolefin	15/16"	150 lb.	PRE5048ZN-3E			
	Soft Rubber		130 lb.	PRE5048ZN-3R			
1/2"-13 x 1" #41	Hard Rubber	15/16"	150 lb.	PRE5048ZN-3H			
	TPR		130 lb.	PRE5048ZN-TPR			
1/2"-13 x 1 1/2" #48	Polyurethane	15/16"	150 lb.	PRE5048ZN-TPU			
	Monotech		160 lb.	PRE5048ZN-MNT			

Dimensions shown are approximate. Contact factory for specific dimensions.
Other fastenings and finishes may be available. Order restrictions may apply.



Wheel Diameter	Fastening Size (Bolt Hole)	Tread Material	Tread Width	Dynamic Load	Mounting Height	Swivel Radius	Part Number
1 5/8"	1 3/16" x 2" (1 3/16" x 1 9/16") #13	Polyolefin Soft Rubber	1 1/16"	75 lb. 70 lb.	2 5/16"	1 5/8"	PRE1613ZN-3E PRE1613ZN-3R
		Polyolefin Soft Rubber Hard Rubber TPR Polyurethane	3/4"	90 lb. 80 lb. 90 lb. 80 lb. 90 lb.			PRE2013ZN-3E PRE2013ZN-3R PRE2013ZN-3H PRE2013ZN-TPR PRE2013ZN-TPU
2"	1 3/16" x 2" (1 3/16" x 1 9/16") #13	Polyolefin Soft Rubber Hard Rubber TPR Polyurethane	3/4"	90 lb. 80 lb. 90 lb. 80 lb. 90 lb.	2 5/8"	1 15/16" 2 1/4" [-B]	PRE2008ZN-3E PRE2008ZN-3R PRE2008ZN-3H PRE2008ZN-TPR PRE2008ZN-TPU
		Polyolefin Soft Rubber Hard Rubber TPR Polyurethane	1 3/16"	90 lb. 80 lb. 90 lb. 80 lb. 90 lb.			PRE2513ZN-3E PRE2513ZN-3R PRE2513ZN-3H PRE2513ZN-TPR PRE2513ZN-TPU
2 1/2"	1 3/16" x 2" (1 3/16" x 1 9/16") #13	Polyolefin Soft Rubber Hard Rubber TPR Polyurethane	1 3/16"	95 lb. 80 lb. 95 lb. 80 lb. 95 lb.	3 3/8"	2 1/8" 2 1/4" [-B]	PRE2508ZN-3E PRE2508ZN-3R PRE2508ZN-3H PRE2508ZN-TPR PRE2508ZN-TPU
		Polyolefin Soft Rubber Hard Rubber TPR Polyurethane	1 3/16"	95 lb. 80 lb. 95 lb. 80 lb. 95 lb.			PRE3013ZN-3E PRE3013ZN-3R PRE3013ZN-3H PRE3013ZN-TPR PRE3013ZN-TPU PRE3013ZN-MNT
3"	1 3/16" x 2" (1 3/16" x 1 9/16") #13	Polyolefin Soft Rubber Hard Rubber TPR Polyurethane Monotech	1 3/16"	120 lb. 110 lb. 120 lb. 110 lb. 120 lb. 120 lb.	3 1/2"	2 3/8" 2 3/8" [-B]	PRE3008ZN-3E PRE3008ZN-3R PRE3008ZN-3H PRE3008ZN-TPR PRE3008ZN-TPU PRE3008ZN-MNT
		Polyolefin Soft Rubber Hard Rubber TPR Polyurethane Monotech	1 3/16"	120 lb. 110 lb. 120 lb. 110 lb. 120 lb. 120 lb.			PRE30120ZN-3E PRE30120ZN-3R PRE30120ZN-3H PRE30120ZN-TPR PRE30120ZN-TPU PRE30120ZN-MNT
		Polyolefin Soft Rubber Hard Rubber TPR Polyurethane Monotech	1 3/16"	120 lb. 110 lb. 120 lb. 110 lb. 120 lb. 120 lb.			PRE40120ZN-3E PRE40120ZN-3R PRE40120ZN-3H PRE40120ZN-TPR PRE40120ZN-TPU PRE40120ZN-MNT
4"	2 5/8" x 3 3/4" (1 3/4" x 2 3/4" - 3") #120	Polyolefin Soft Rubber Hard Rubber TPR Polyurethane Monotech	1 5/16"	150 lb. 125 lb. 150 lb. 125 lb. 150 lb. 150 lb.	4 3/4"	3 5/16" 3 5/16" [-B]	PRE50120ZN-3E PRE50120ZN-3R PRE50120ZN-3H PRE50120ZN-TPR PRE50120ZN-TPU PRE50120ZN-MNT
		Polyolefin Soft Rubber Hard Rubber TPR Polyurethane Monotech	1 5/16"	150 lb. 130 lb. 150 lb. 130 lb. 150 lb. 160 lb.			PRE50120ZN-3E PRE50120ZN-3R PRE50120ZN-3H PRE50120ZN-TPR PRE50120ZN-TPU PRE50120ZN-MNT

Rigid models on next page.
For detailed plate information, see back of catalog.

Dimensions shown are approximate. Contact factory for specific dimensions.
Other fastenings and finishes may be available. Order restrictions may apply.



Wheel Diameter	Fastening Size (Bolt Hole)	Tread Material	Tread Width	Dynamic Load	Mounting Height	Swivel Radius	Part Number
3"	2 ⁵ / ₈ " x 3 ³ / ₄ " (1 ³ / ₄ " x 2 ³ / ₄ " - 3") #120	Polyolefin	1 ³ / ₁₆ "	120 lb.	3 ¹ / ₂ "	n/a	PRI30120ZN-3E
		Soft Rubber		110 lb.			PRI30120ZN-3R
		Hard Rubber		120 lb.			PRI30120ZN-3H
		TPR		110 lb.			PRI30120ZN-TPR
		Polyurethane		120 lb.			PRI30120ZN-TPU
Monotech	120 lb.	PRI30120ZN-MNT					
4"	2 ⁵ / ₈ " x 3 ³ / ₄ " (1 ³ / ₄ " x 2 ³ / ₄ " - 3") #120	Polyolefin	1 ⁵ / ₁₆ "	150 lb.	4 ³ / ₄ "	n/a	PRI40120ZN-3E
		Soft Rubber		125 lb.			PRI40120ZN-3R
		Hard Rubber		150 lb.			PRI40120ZN-3H
		TPR		125 lb.			PRI40120ZN-TPR
		Polyurethane		150 lb.			PRI40120ZN-TPU
Monotech	150 lb.	PRI40120ZN-MNT					
5"	2 ⁵ / ₈ " x 3 ³ / ₄ " (1 ³ / ₄ " x 2 ³ / ₄ " - 3") #120	Polyolefin	1 ⁵ / ₁₆ "	150 lb.	5 ³ / ₄ "	n/a	PRI50120ZN-3E
		Soft Rubber		130 lb.			PRI50120ZN-3R
		Hard Rubber		150 lb.			PRI50120ZN-3H
		TPR		130 lb.			PRI50120ZN-TPR
		Polyurethane		150 lb.			PRI50120ZN-TPU
Monotech	160 lb.	PRI50120ZN-MNT					

For detailed plate information, see back of catalog.



Wheel Diameter	Fastening Size	Tread Material	Tread Width	Dynamic Load	Mounting Height	Swivel Radius	Part Number
1 5/8"	3/8" x 1" #22 Grip Ring	Polyolefin Soft Rubber	1 1/16"	75 lb. 70 lb.	2 5/16"	1 5/8"	PRE1622ZN-3E PRE1622ZN-3R
	7/16" x 7/8" #23 Grip Ring	Polyolefin Soft Rubber	1 1/16"	75 lb. 70 lb.			PRE1623ZN-3E PRE1623ZN-3R
2"	5/16" x 1 1/2" #02 Grip Neck	Polyolefin Soft Rubber Hard Rubber TPR Polyurethane	3/4"	90 lb. 80 lb.	2 5/8"	1 5/16" 2 1/4" [-B]	PRE2002ZN-3E PRE2002ZN-3R
			1 3/16"	90 lb. 80 lb.			PRE2002ZN-3H PRE2002ZN-TPR PRE2002ZN-TPU
	3/8" x 1" #22 Grip Ring	Polyolefin Soft Rubber Hard Rubber TPR Polyurethane	3/4"	90 lb. 80 lb.			PRE2022ZN-3E PRE2022ZN-3R
			1 3/16"	90 lb. 80 lb.			PRE2022ZN-3H PRE2022ZN-TPR PRE2022ZN-TPU
	7/16" x 7/8" #23 Grip Ring	Polyolefin Soft Rubber Hard Rubber TPR Polyurethane	3/4"	90 lb. 80 lb.			PRE2023ZN-3E PRE2023ZN-3R
			1 3/16"	90 lb. 80 lb.			PRE2023ZN-3H PRE2023ZN-TPR PRE2023ZN-TPU
7/16" x 1 7/16" #11 Grip Ring	Polyolefin Soft Rubber Hard Rubber TPR Polyurethane	3/4"	90 lb. 80 lb.	PRE2011ZN-3E PRE2011ZN-3R			
7/16" x 1 7/16" #73 Brass Band	Polyolefin Soft Rubber Hard Rubber TPR Polyurethane	1 3/16"	90 lb. 80 lb.	PRE2011ZN-3H PRE2011ZN-TPR PRE2011ZN-TPU			
2 1/2"	5/16" x 1 1/2" #02 Grip Neck	Polyolefin Soft Rubber Hard Rubber TPR Polyurethane	1 3/16"	95 lb. 80 lb.	3 1/8"	2 1/8" 2 1/4" [-B]	PRE2502ZN-3E PRE2502ZN-3R
				95 lb. 80 lb.			PRE2502ZN-3H PRE2502ZN-TPR PRE2502ZN-TPU
	3/8" x 1" #22 Grip Ring	Polyolefin Soft Rubber Hard Rubber TPR Polyurethane	1 3/16"	95 lb. 80 lb.			PRE2522ZN-3E PRE2522ZN-3R
				95 lb. 80 lb.			PRE2522ZN-3H PRE2522ZN-TPR PRE2522ZN-TPU
	7/16" x 7/8" #23 Grip Ring	Polyolefin Soft Rubber Hard Rubber TPR Polyurethane	1 3/16"	95 lb. 80 lb.			PRE2523ZN-3E PRE2523ZN-3R
95 lb. 80 lb.				PRE2523ZN-3H PRE2523ZN-TPR PRE2523ZN-TPU			
7/16" x 1 7/16" #11 Grip Ring	Polyolefin Soft Rubber Hard Rubber TPR Polyurethane	1 3/16"	95 lb. 80 lb.	PRE2511ZN-3E PRE2511ZN-3R			
7/16" x 1 7/16" #73 Brass Band	Polyolefin Soft Rubber Hard Rubber TPR Polyurethane	1 3/16"	95 lb. 80 lb.	PRE2511ZN-3H PRE2511ZN-TPR PRE2511ZN-TPU			
2 1/2"	7/16" x 1 7/16" #73 Brass Band	Polyolefin Soft Rubber Hard Rubber TPR Polyurethane	1 3/16"	95 lb. 80 lb.	3 1/8"	2 1/8" 2 1/4" [-B]	PRE2573ZN-3E PRE2573ZN-3R
				95 lb. 80 lb.			PRE2573ZN-3H PRE2573ZN-TPR PRE2573ZN-TPU
	7/16" x 1 7/16" #73 Brass Band	Polyolefin Soft Rubber Hard Rubber TPR Polyurethane	1 3/16"	95 lb. 80 lb.			PRE2573ZN-3E PRE2573ZN-3R
				95 lb. 80 lb.			PRE2573ZN-3H PRE2573ZN-TPR PRE2573ZN-TPU

Dimensions shown are approximate. Contact factory for specific dimensions.
Other fastenings and finishes may be available. Order restrictions may apply.

Wheel Diameter	Fastening Size	Tread Material	Tread Width	Dynamic Load	Mounting Height	Swivel Radius	Part Number
3"	5/16" x 1 1/2" #02 Grip Neck	Polyolefin	13/16"	120 lb.			PRE3002ZN-3E
		Soft Rubber		110 lb.			PRE3002ZN-3R
		Hard Rubber		120 lb.			PRE3002ZN-3H
		TPR		110 lb.			PRE3002ZN-TPR
		Polyurethane		120 lb.			PRE3002ZN-TPU
		Monotech	120 lb.	PRE3002ZN-MNT			
	3/8" x 1" #22 Grip Ring	Polyolefin	13/16"	120 lb.			PRE3022ZN-3E
Soft Rubber		110 lb.		PRE3022ZN-3R			
Hard Rubber		120 lb.		PRE3022ZN-3H			
TPR		110 lb.		PRE3022ZN-TPR			
Polyurethane		120 lb.		PRE3022ZN-TPU			
		Monotech	120 lb.	PRE3022ZN-MNT			
	7/16" x 7/8" #23 Grip Ring	Polyolefin	13/16"	120 lb.	3 1/2"	2 3/8" 2 3/8" [-B]	PRE3023ZN-3E
Soft Rubber		110 lb.		PRE3023ZN-3R			
Hard Rubber		120 lb.		PRE3023ZN-3H			
TPR		110 lb.		PRE3023ZN-TPR			
Polyurethane		120 lb.		PRE3023ZN-TPU			
		Monotech	120 lb.	PRE3023ZN-MNT			
	7/16" x 1 7/16" #11 Grip Ring	Polyolefin	13/16"	120 lb.			PRE3011ZN-3E
Soft Rubber		110 lb.		PRE3011ZN-3R			
Hard Rubber		120 lb.		PRE3011ZN-3H			
TPR		110 lb.		PRE3011ZN-TPR			
Polyurethane		120 lb.		PRE3011ZN-TPU			
		Monotech	120 lb.	PRE3011ZN-MNT			
	7/16" x 1 7/16" #73 Brass Band	Polyolefin	13/16"	120 lb.			PRE3073ZN-3E
Soft Rubber		110 lb.		PRE3073ZN-3R			
Hard Rubber		120 lb.		PRE3073ZN-3H			
TPR		110 lb.		PRE3073ZN-TPR			
Polyurethane		120 lb.		PRE3073ZN-TPU			
		Monotech	120 lb.	PRE3073ZN-MNT			
4"	7/16" x 1 7/16" #73 Brass Band	Polyolefin	15/16"	150 lb.	4 3/4"	3 5/16" 3 5/16" [-B]	PRE4073ZN-3E
		Soft Rubber		125 lb.			PRE4073ZN-3R
		Hard Rubber	150 lb.	PRE4073ZN-3H			
		TPR	125 lb.	PRE4073ZN-TPR			
		Polyurethane	150 lb.	PRE4073ZN-TPU			
		Monotech	150 lb.	PRE4073ZN-MNT			
	7/16" x 2" #204 Brass Band	Polyolefin	15/16"	150 lb.			PRE40204ZN-3E
				Soft Rubber			125 lb.
		Hard Rubber	150 lb.	PRE40204ZN-3H			
		TPR	125 lb.	PRE40204ZN-TPR			
		Polyurethane	150 lb.	PRE40204ZN-TPU			
		Monotech	150 lb.	PRE40204ZN-MNT			
5"	7/16" x 1 7/16" #73 Brass Band	Polyolefin	15/16"	150 lb.	5 3/4"	4 1/8" 4 1/8" [-B]	PRE5073ZN-3E
		Soft Rubber		130 lb.			PRE5073ZN-3R
		Hard Rubber	150 lb.	PRE5073ZN-3H			
		TPR	130 lb.	PRE5073ZN-TPR			
		Polyurethane	150 lb.	PRE5073ZN-TPU			
		Monotech	160 lb.	PRE5073ZN-MNT			
	7/16" x 2" #204 Brass Band	Polyolefin	15/16"	150 lb.			PRE50204ZN-3E
				Soft Rubber			130 lb.
		Hard Rubber	150 lb.	PRE50204ZN-3H			
		TPR	130 lb.	PRE50204ZN-TPR			
		Polyurethane	150 lb.	PRE50204ZN-TPU			
		Monotech	160 lb.	PRE50204ZN-MNT			

Dimensions shown are approximate. Contact factory for specific dimensions.
Other fastenings and finishes may be available. Order restrictions may apply.

MONARCH

Single Wheel Hooded Casters 2", 2½", 3"

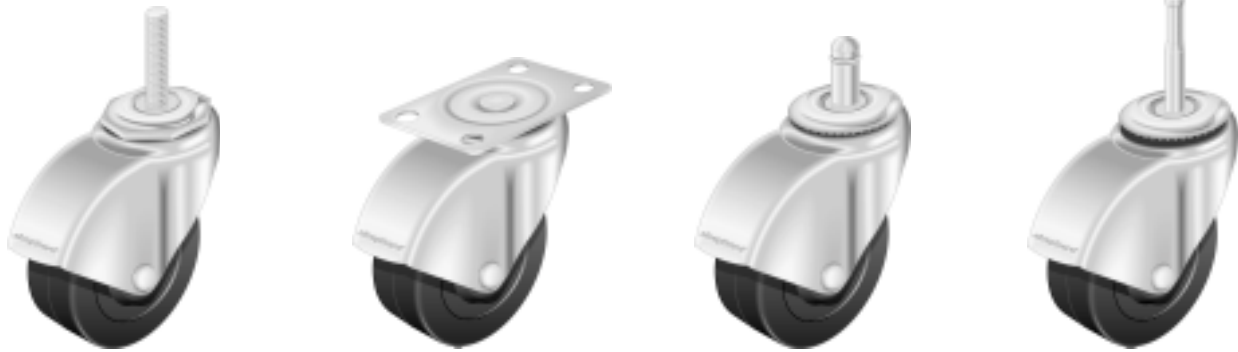

STANDARD FEATURES

- Zinc finish
- Double ball bearing raceways
- Octagon washer on threaded stem models
- Heat treated
- Meets or exceeds ANSI/BIFMA and ICM standards for the caster industry

APPLICATIONS

- Fixtures
- Institutional Equipment
- Medical Equipment
- Equipment Carts
- Furniture

OPTIONS

OTHER FINISHES

Polished Nickel [PN]
 Insert finish code for [ZN] in Part Number. Minimum order quantities may apply.

OTHER FASTENINGS

Other fastenings may be available. Consult factory.

BRAKE

Brake option available on 2", 2½", and 3" models only. Minimum order quantities may apply
 For brake option, insert [-B] at the end of the Part Number.



THREADED STEM WASHER WRENCH

Use to hold caster in place while assembling to unit. To order use Part Number [Wrench RE GS GT ZN].



WHEEL SELECTION



SOFT [-R]* AND HARD [-H] RUBBER



POLYOLEFIN [-E]



POLYURETHANE [-TPU]



THERMOPLASTIC RUBBER [-TPR]



3" GRAY MONOTECH Insert [-MNT] for Wheel Code (Example: PMN3007ZN-MNT).



2" SOLID POLYURETHANE Insert [-3ES] for Wheel Code (Example: PMN2007ZN-3ES).

*Soft Rubber Conductive Tread available on 2", 2½", and 3". Minimum order quantity may apply.



Wheel Diameter	Fastening Size	Tread Material	Tread Width	Dynamic Load	Mounting Height	Swivel Radius	Part Number
2"	5/16"-18 x 1" #07	Polyolefin	3/4"	90 lb.	2 5/8"	2 1/16" 2 1/4" [-B]	PMN2007ZN-3E
		Soft Rubber	13/16"	80 lb.			PMN2007ZN-3R
	Hard Rubber	90 lb.		PMN2007ZN-3H			
	TPR	80 lb.	PMN2007ZN-TPR				
Polyurethane	90 lb.	PMN2007ZN-TPU					
3/8"-16 x 1 1/2" #05	Polyolefin	3/4"	90 lb.	3 1/8"	2 1/8" 2 1/4" [-B]	PMN2005ZN-3E	
	Soft Rubber	13/16"	80 lb.			PMN2005ZN-3R	
Hard Rubber	90 lb.		PMN2005ZN-3H				
TPR	80 lb.	PMN2005ZN-TPR					
Polyurethane	90 lb.	PMN2005ZN-TPU					
2 1/2"	5/16"-18 x 1" #07	Polyolefin	13/16"	95 lb.	3 1/8"	2 1/8" 2 1/4" [-B]	PMN2507ZN-3E
		Soft Rubber		80 lb.			PMN2507ZN-3R
	Hard Rubber	95 lb.	PMN2507ZN-3H				
	TPR	80 lb.	PMN2507ZN-TPR				
Polyurethane	95 lb.	PMN2507ZN-TPU					
3/8"-16 x 1 1/2" #05	Polyolefin	13/16"	95 lb.	3 1/2"	2 1/2" 2 1/2" [-B]	PMN2505ZN-3E	
	Soft Rubber		80 lb.			PMN2505ZN-3R	
Hard Rubber	95 lb.	PMN2505ZN-3H					
TPR	80 lb.	PMN2505ZN-TPR					
Polyurethane	95 lb.	PMN2505ZN-TPU					
3"	5/16"-18 x 1" #07	Polyolefin	13/16"	120 lb.	3 1/2"	2 1/2" 2 1/2" [-B]	PMN3007ZN-3E
		Soft Rubber		110 lb.			PMN3007ZN-3R
	Hard Rubber	120 lb.	PMN3007ZN-3H				
	TPR	110 lb.	PMN3007ZN-TPR				
Polyurethane	120 lb.	PMN3007ZN-TPU					
3/8"-16 x 1 1/2" #05	Polyolefin	13/16"	120 lb.	3 1/2"	2 1/2" 2 1/2" [-B]	PMN3005ZN-3E	
	Soft Rubber		110 lb.			PMN3005ZN-3R	
Hard Rubber	120 lb.	PMN3005ZN-3H					
TPR	110 lb.	PMN3005ZN-TPR					
Polyurethane	120 lb.	PMN3005ZN-TPU					

Dimensions shown are approximate. Contact factory for specific dimensions.
Other fastenings and finishes may be available. Order restrictions may apply.



Wheel Diameter	Fastening Size (Bolt Hole)	Tread Material	Tread Width	Dynamic Load	Mounting Height	Swivel Radius	Part Number
2"	1 ³ / ₁₆ " x 2" (1 ³ / ₁₆ " x 1 ⁹ / ₁₆ ") #13	Polyolefin	3/4"	90 lb.	2 ⁵ / ₈ "	2 ⁷ / ₁₆ " 2 ¹ / ₄ " [-B]	PMN2013ZN-3E
		Soft Rubber	1 ³ / ₁₆ "	80 lb.			PMN2013ZN-3R
	Hard Rubber	90 lb.		PMN2013ZN-3H			
	TPR	80 lb.	PMN2013ZN-TPR				
Polyurethane	90 lb.	PMN2013ZN-TPU					
1 ³ / ₄ " x 2 ⁵ / ₈ " (1 ⁵ / ₁₆ " x 2 ¹ / ₈ ") #08	Polyolefin	3/4"	90 lb.	PMN2008ZN-3E			
	Soft Rubber	1 ³ / ₁₆ "	80 lb.	PMN2008ZN-3R			
Hard Rubber	90 lb.		PMN2008ZN-3H				
TPR	80 lb.	PMN2008ZN-TPR					
Polyurethane	90 lb.	PMN2008ZN-TPU					
2 1/2"	1 ³ / ₁₆ " x 2" (1 ³ / ₁₆ " x 1 ⁹ / ₁₆ ") #13	Polyolefin	1 ³ / ₁₆ "	95 lb.	3 ¹ / ₈ "	2 ¹ / ₈ " 2 ¹ / ₄ " [-B]	PMN2513ZN-3E
		Soft Rubber		80 lb.			PMN2513ZN-3R
	Hard Rubber	95 lb.	PMN2513ZN-3H				
	TPR	80 lb.	PMN2513ZN-TPR				
Polyurethane	95 lb.	PMN2513ZN-TPU					
1 ³ / ₄ " x 2 ⁵ / ₈ " (1 ⁵ / ₁₆ " x 2 ¹ / ₈ ") #08	Polyolefin	1 ³ / ₁₆ "	95 lb.	PMN2508ZN-3E			
	Soft Rubber		80 lb.	PMN2508ZN-3R			
Hard Rubber	95 lb.	PMN2508ZN-3H					
TPR	80 lb.	PMN2508ZN-TPR					
Polyurethane	95 lb.	PMN2508ZN-TPU					
3"	1 ³ / ₁₆ " x 2" (1 ³ / ₁₆ " x 1 ⁹ / ₁₆ ") #13	Polyolefin	1 ³ / ₁₆ "	120 lb.	3 ¹ / ₂ "	2 ¹ / ₂ " [-B] 2 ¹ / ₂ "	PMN3013ZN-3E
		Soft Rubber		110 lb.			PMN3013ZN-3R
	Hard Rubber	120 lb.	PMN3013ZN-3H				
	TPR	110 lb.	PMN3013ZN-TPR				
Polyurethane	120 lb.	PMN3013ZN-TPU					
1 ³ / ₄ " x 2 ⁵ / ₈ " (1 ⁵ / ₁₆ " x 2 ¹ / ₈ ") #08	Polyolefin	1 ³ / ₁₆ "	120 lb.	PMN3008ZN-3E			
	Soft Rubber		110 lb.	PMN3008ZN-3R			
Hard Rubber	120 lb.	PMN3008ZN-3H					
TPR	110 lb.	PMN3008ZN-TPR					
Polyurethane	120 lb.	PMN3008ZN-TPU					

For detailed plate information, see back of catalog.



Wheel Diameter	Fastening Size	Tread Material	Tread Width	Dynamic Load	Mounting Height	Swivel Radius	Part Number
2"	5/16" x 1 1/2" #02 Grip Neck	Polyolefin	3/4"	90 lb.	2 5/8"	2 1/16" 2 1/4" [-B]	PMN2002ZN-3E
		Soft Rubber	13/16"	80 lb.			PMN2002ZN-3R
		Hard Rubber		90 lb.			PMN2002ZN-3H
	7/16" x 7/8" #23 Grip Ring	TPR	3/4"	80 lb.			PMN2002ZN-TPR
		Polyurethane		90 lb.			PMN2002ZN-TPU
		Polyolefin	13/16"	90 lb.			PMN2023ZN-3E
Soft Rubber	80 lb.	PMN2023ZN-3R					
Hard Rubber	3/4"	90 lb.	PMN2023ZN-3H				
TPR		80 lb.	PMN2023ZN-TPR				
Polyurethane	90 lb.	PMN2023ZN-TPU					
2 1/2"	7/16" x 7/8" #23 Grip Ring	Polyolefin	13/16"	95 lb.	3 1/8"	2 1/8" 2 1/4" [-B]	PMN2523ZN-3E
		Soft Rubber		80 lb.			PMN2523ZN-3R
		Hard Rubber		95 lb.			PMN2523ZN-3H
	TPR	80 lb.	PMN2523ZN-TPR				
	Polyurethane	95 lb.	PMN2523ZN-TPU				
	7/16" x 1 7/16" #11 Grip Ring	Polyolefin	13/16"	95 lb.			PMN2511ZN-3E
Soft Rubber		80 lb.		PMN2511ZN-3R			
Hard Rubber		95 lb.		PMN2511ZN-3H			
TPR	80 lb.	PMN2511ZN-TPR					
Polyurethane	95 lb.	PMN2511ZN-TPU					
3"	7/16" x 7/8" #23 Grip Ring	Polyolefin	13/16"	120 lb.	3 1/2"	2 1/2" 2 1/2" [-B]	PMN3023ZN-3E
		Soft Rubber		110 lb.			PMN3023ZN-3R
		Hard Rubber		120 lb.			PMN3023ZN-3H
	TPR	110 lb.	PMN3023ZN-TPR				
	Polyurethane	120 lb.	PMN3023ZN-TPU				
	7/16" x 1 7/16" #11 Grip Ring	Polyolefin	13/16"	120 lb.			PMN3011ZN-3E
Soft Rubber		110 lb.		PMN3011ZN-3R			
Hard Rubber		120 lb.		PMN3011ZN-3H			
TPR	110 lb.	PMN3011ZN-TPR					
Polyurethane	120 lb.	PMN3011ZN-TPU					

Dimensions shown are approximate. Contact factory for specific dimensions.
Other fastenings and finishes may be available. Order restrictions may apply.

BARON

Spherical Wheel Casters 1 5/8", 2"



STANDARD FEATURES

- Double ball bearing raceways
- Heat treated in the 2" model only
- Meets or exceeds ANSI/BIFMA standards for seating in the 2" model

APPLICATIONS

- Furniture
- Fixtures
- Medical Equipment
- Office Equipment

WHEEL SELECTIONS



Available in 1 5/8"
Baron model only
SPHERICAL
SOFT RUBBER [-3RD]



Available in 2"
Baron model only
SPHERICAL
POLYOLEFIN [-3ED]

OPTION

FINISH OPTIONS

Bright Chrome (2" only) [BC]
Metalized Brass [MB]
Windsor Antique [WA]

Threaded Stems

Wheel Diameter	Fastening Size	Tread Material	Finish Options	Dynamic Load	Mounting Height	Swivel Radius	Part Number
1 5/8"	5/16"-18 x 3/4" #32	Rubber	Metalized Brass Windsor Antique	70 lb.	2 5/16"	1 3/4"	PBH1632MB-3RD PBH1632WA-3RD
	5/16"-18 x 1" #07	Rubber	Metalized Brass Windsor Antique	70 lb.			PBH1607MB-3RD PBH1607WA-3RD
2"	5/16"-18 x 1/2" #25	Polyolefin	Bright Chrome Metalized Brass Windsor Antique	80 lb.	2 5/8"	2 1/4"	PBH2025BC-3ED PBH2025MB-3ED PBH2025WA-3ED
	5/16"-18 x 3/4" #32	Polyolefin	Bright Chrome Metalized Brass Windsor Antique	80 lb.			PBH2032BC-3ED PBH2032MB-3ED PBH2032WA-3ED
	5/16"-18 x 1" #07	Polyolefin	Bright Chrome Metalized Brass Windsor Antique	80 lb.			PBH2007BC-3ED PBH2007MB-3ED PBH2007WA-3ED
	3/8"-16 x 1" #34	Polyolefin	Bright Chrome Metalized Brass Windsor Antique	80 lb.			PBH2034BC-3ED PBH2034MB-3ED PBH2034WA-3ED
	3/8"-16 x 1 1/2" #05	Polyolefin	Bright Chrome Metalized Brass Windsor Antique	80 lb.			PBH2005BC-3ED PBH2005MB-3ED PBH2005WA-3ED

Dimensions shown are approximate. Contact factory for specific dimensions.
Other fastenings and finishes may be available. Order restrictions may apply.



Plates

Wheel Diameter	Fastening Size	Tread Material	Finish Options	Dynamic Load	Mounting Height	Swivel Radius	Part Number
1 5/8"	1 3/16" x 2" (1 3/16" x 1 9/16") #13	Rubber	Metalized Brass	70 lb.	2 5/16"	1 3/4"	PBH1613MB-3RD
			Windsor Antique				PBH1613WA-3RD
2"	1 3/16" x 2" (1 3/16" x 1 9/16") #13	Polyolefin	Bright Chrome	80 lb.	2 5/8"	2 1/4"	PBH2013BC-3ED
			Metalized Brass				PBH2013MB-3ED
			Windsor Antique				PBH2013WA-3ED

For detailed plate information, see back of catalog.



Grip Neck and Grip Ring Stems

Wheel Diameter	Fastening Size	Tread Material	Finish Options	Dynamic Load	Mounting Height	Swivel Radius	Part Number
1 5/8"	5/16" x 1 1/2" #02 Grip Neck	Rubber	Metalized Brass Windsor Antique	70 lb.	2 5/16"	1 3/4"	PBH1602MB-3RD
	7/16" x 7/8" #23 Grip Ring	Rubber	Metalized Brass Windsor Antique	70 lb.			PBH1623MB-3RD
	7/16" x 1 7/16" #11 Grip Ring	Rubber	Metalized Brass Windsor Antique	70 lb.			PBH1611MB-3RD
2"	5/16" x 1 1/2" #02 Grip Neck	Polyolefin	Bright Chrome Metalized Brass Windsor Antique	80 lb.	2 5/8"	2 1/4"	PBH2002MB-3ED
	3/8" x 1" #22 Grip Ring	Polyolefin	Bright Chrome Metalized Brass Windsor Antique	80 lb.			PBH2022MB-3ED
	7/16" x 7/8" #23 Grip Ring	Polyolefin	Bright Chrome Metalized Brass Windsor Antique	80 lb.			PBH2023MB-3ED
	7/16" x 1 7/16" #11 Grip Ring	Polyolefin	Bright Chrome Metalized Brass Windsor Antique	80 lb.			PBH2011MB-3ED

Dimensions shown are approximate. Contact factory for specific dimensions.
Other fastenings and finishes may be available. Order restrictions may apply.

OMEGA

Elite Hooded Wheel Casters 2" and 3"



STANDARD FEATURES

- Fully heat treated
- Dual ball bearing raceways
- High luster chrome finish
- Matching chrome thread guards
- Bolt-In stem assortment (3" dia. models)
- Omega features Soft 50/60A durometer, non-marking neoprene wheel with precision bearing for maximum shock absorption and excellent mobility

APPLICATIONS

- Medical equipment
- Seating
- Electronic equipment

OPTIONS

BRAKE

Tread brake uniformly integrated into body design for smooth look and ease of activation. Available on 3" model only. *Add -B to the end of part number.*



BOLT-IN STEMS

A variety of "bolt-in" stems can be attached to the kingpinless fastening #403 providing the ultimate in versatility. Contact factory for bolt-in stem part numbers.



Kingpinless

Wheel Diameter	Fastening Size	Tread Material	Tread Width	Dynamic Load	Mounting Height	Swivel Radius	Part Number
3"	7/16" Kingpinless* #403	Neoprene	15/16"	110 lb.	3 7/8"	2 7/8" 3" [-B]	POM30403BC-NPR

* Recommended mounting bolt 3/8" diameter - 16 x 1/2" minimum.



Grip Neck, Grip Ring and Plain

Wheel Diameter	Fastening Size	Tread Material	Tread Width	Dynamic Load	Mounting Height	Swivel Radius	Part Number
2"	7/16" x 1" #201 Grip Ring	Neoprene	15/16"	75 lb.	2 3/4"	2"	POM20201BC-NPR
3"	3/8" x 7/8" #22 Grip Ring	Neoprene	15/16"	110 lb.	3 7/8"	3" [-B]	POM3022BC-NPR
	7/16" x 7/8" #23 Grip Ring	Neoprene	15/16"	110 lb.			POM3023BC-NPR
	7/16" x 1 1/16" #11 Grip Ring	Neoprene	15/16"	110 lb.			POM3011BC-NPR
	7/16" x 1 7/8" #19 Plain Stem	Neoprene	15/16"	110 lb.			POM3019BC-NPR
	5/16" x 1 1/2" #02 Grip Neck Stem	Neoprene	15/16"	110 lb.			POM3002BC-NPR

Dimensions shown are approximate. Contact factory for specific dimensions. Other fastenings and finishes may be available. Order restrictions may apply.

INSTITUTIONAL

Total Lock, Swivel, and Rigid Casters 3", 4", 5"



STANDARD FEATURES

- Constructed of high-strength steel for added durability
- Plate, threaded stem and hollow king pin fastenings
- All institutional series casters without thread guards are NSF approved
- Dual ball bearing raceway
- Zinc plated finish
- 3/8" diameter nut and bolt axle
- Plastic thread guards standard on 4" and 5" models with ball bearing wheels
- Ball or nylon bearings



APPLICATIONS

- Hospital Equipment
- Office Equipment
- Utility Carts
- Food Service
- Store Fixtures
- Institutional Equipment

OPTIONS

TREAD LOCK BRAKE

Available on swivel models. For tread lock brake option, insert [TB] at the end of the Part Number.



TOP LOCK BRAKE

Available Fall 2002. For factory installed insert [-TL] at end of part number, for field installable kit consult the factory for the kit part #.



EXPANDING ADAPTER STEMS

Consult factory for part numbers and pricing.



HOLLOW KING PIN 3/8" BOLT ADAPTER

Allows a 3/8" diameter bolt to be used with hollow king pin. To order use Part Number [Bushing 3/8 GT].



THREADED STEM WASHER WRENCH

Use to hold caster in place while assembling to unit. To order use Part Number [Wrench RE GS GT ZN].



WHEEL SELECTIONS



POLYURETHANE
Includes ball bearings and thread guards [-TPU22*]. Available in Blue or Gray



THERMOPLASTIC RUBBER
Includes ball bearings and thread guards [-TPR22*]



THERMOPLASTIC RUBBER
TPR wheel with Nylon Bearings [-TPR11]

*To order 4" and 5" wheels without thread guards change [22] to [21].



Total Lock Models

Wheel Diameter	Fastening Size	Tread Material	Bearing Type	Tread Width	Dynamic Load	Mounting Height	Swivel Radius	Part Number
3"	Hollow King Pin 1/2" dia. x 3/4" length #400	TPR TPR TPU-Grey on Grey TPU-Blue on Grey	Nylon Ball Ball Ball	1 1/4"	165 lb. 165 lb. 185 lb. 185 lb.	4 1/8"	4 3/8"	PGT30400ZN-TPR11(GG) PGT30400ZN-TPR21(GG) PGT30400ZN-TPU21(GG) PGT30400ZN-TPU21(BG)
4"	Hollow King Pin 1/2" dia. x 3/4" length #400	TPR TPR TPU-Grey on Grey TPU-Blue on Grey	Nylon Ball Ball Ball	1 1/4"	185 lb. 185 lb. 200 lb. 200 lb.	5 1/8"	4 3/8"	PGT40400ZN-TPR11(GG) PGT40400ZN-TPR22(GG) PGT40400ZN-TPU22(GG) PGT40400ZN-TPU22(BG)
5"	Hollow King Pin 1/2" dia. x 3/4" length #400	TPR TPR TPU-Grey on Grey TPU-Blue on Grey	Nylon Ball Ball Ball	1 1/4"	200 lb. 200 lb. 225 lb. 225 lb.	6 1/8"	4 3/8"	PGT50400ZN-TPR11(GG) PGT50400ZN-TPR22(GG) PGT50400ZN-TPU22(GG) PGT50400ZN-TPU22(BG)



Swivel Models

Wheel Diameter	Fastening Size	Tread Material	Bearing Type	Tread Width	Dynamic Load	Mounting Height	Swivel Radius	Part Number
3"	Hollow King Pin 1/2" dia. x 3/4" length #400	TPR TPR TPU-Grey on Grey TPU-Blue on Grey	Nylon Ball Ball Ball	1 1/4"	165 lb. 165 lb. 185 lb. 185 lb.	4 1/8"	2 13/16"	PGS30400ZN-TPR11(GG) PGS30400ZN-TPR21(GG) PGS30400ZN-TPU21(GG) PGS30400ZN-TPU21(BG)
4"	Hollow King Pin 1/2" dia. x 3/4" length #400	TPR TPR TPU-Grey on Grey TPU-Blue on Grey	Nylon Ball Ball Ball	1 1/4"	185 lb. 185 lb. 200 lb. 200 lb.	5 1/8"	3 5/16"	PGS40400ZN-TPR11(GG) PGS40400ZN-TPR22(GG) PGS40400ZN-TPU22(GG) PGS40400ZN-TPU22(BG)
5"	Hollow King Pin 1/2" dia. x 3/4" length #400	TPR TPR TPU-Grey on Grey TPU-Blue on Grey	Nylon Ball Ball Ball	1 1/4"	200 lb. 200 lb. 225 lb. 225 lb.	6 1/8"	4 3/16"	PGS50400ZN-TPR11(GG) PGS50400ZN-TPR22(GG) PGS50400ZN-TPU22(GG) PGS50400ZN-TPU22(BG)

For Tread Lock Brake add -TB to end of the part number.

Dimensions shown are approximate. Contact factory for specific dimensions.
Other fastenings and finishes may be available. Order restrictions may apply.



Total Lock Models

Wheel Diameter	Fastening Size	Tread Material	Bearing Type	Tread Width	Dynamic Load	Mounting Height	Swivel Radius	Part Number
3"	1/2" -13 x 1" #41	TPR TPR TPU-Grey on Grey TPU-Blue on Grey	Nylon Ball Ball Ball Ball	1 1/4"	165 lb. 165 lb. 185 lb. 185 lb.	4 1/4"	4 3/8"	PGT3041ZN-TPR11(GG) PGT3041ZN-TPR21(GG) PGT3041ZN-TPU21(GG) PGT3041ZN-TPU21(BG)
	1/2" -13 x 1 1/2" #48	TPR TPR TPU-Grey on Grey TPU-Blue on Grey	Nylon Ball Ball Ball Ball	1 1/4"	165 lb. 165 lb. 185 lb. 185 lb.			PGT3048ZN-TPR11(GG) PGT3048ZN-TPR21(GG) PGT3048ZN-TPU21(GG) PGT3048ZN-TPU21(BG)
4"	1/2" -13 x 1" #41	TPR TPR TPU-Grey on Grey TPU-Blue on Grey	Nylon Ball Ball Ball Ball	1 1/4"	185 lb. 185 lb. 200 lb. 200 lb.	5 1/4"	4 3/8"	PGT4041ZN-TPR11(GG) PGT4041ZN-TPR22(GG) PGT4041ZN-TPU22(GG) PGT4041ZN-TPU22(BG)
	1/2" -13 x 1 1/2" #48	TPR TPR TPU-Grey on Grey TPU-Blue on Grey	Nylon Ball Ball Ball Ball	1 1/4"	185 lb. 185 lb. 200 lb. 200 lb.			PGT4048ZN-TPR11(GG) PGT4048ZN-TPR22(GG) PGT4048ZN-TPU22(GG) PGT4048ZN-TPU22(BG)
5"	1/2" -13 x 1" #41	TPR TPR TPU-Grey on Grey TPU-Blue on Grey	Nylon Ball Ball Ball Ball	1 1/4"	200 lb. 200 lb. 225 lb. 225 lb.	6 1/4"	4 3/8"	PGT5041ZN-TPR11(GG) PGT5041ZN-TPR22(GG) PGT5041ZN-TPU22(GG) PGT5041ZN-TPU22(BG)
	1/2" -13 x 1 1/2" #48	TPR TPR TPU-Grey on Grey TPU-Blue on Grey	Nylon Ball Ball Ball Ball	1 1/4"	200 lb. 200 lb. 225 lb. 225 lb.			PGT5048ZN-TPR11(GG) PGT5048ZN-TPR22(GG) PGT5048ZN-TPU22(GG) PGT5048ZN-TPU22(BG)

Dimensions shown are approximate. Contact factory for specific dimensions.
Other fastenings and finishes may be available. Order restrictions may apply.



Swivel Models

Wheel Diameter	Fastening Size	Tread Material	Bearing Type	Tread Width	Dynamic Load	Mounting Height	Swivel Radius	Part Number
3"	1/2" -13 x 1" #41	TPR	Nylon Ball	1 1/4"	165 lb.	4 1/4"	2 13/16"	PGS3041ZN-TPR11(GG)
		TPR	Ball		165 lb.			PGS3041ZN-TPR21(GG)
3"	1/2" -13 x 1 1/2" #48	TPU-Grey on Grey	Ball	1 1/4"	185 lb.	4 1/4"	2 13/16"	PGS3041ZN-TPU21(GG)
		TPU-Blue on Grey	Ball		185 lb.			PGS3041ZN-TPU21(BG)
4"	1/2" -13 x 1" #41	TPR	Nylon Ball	1 1/4"	165 lb.	5 1/4"	3 5/16"	PGS3048ZN-TPR11(GG)
		TPR	Ball		165 lb.			PGS3048ZN-TPR21(GG)
4"	1/2" -13 x 1 1/2" #48	TPU-Grey on Grey	Ball	1 1/4"	185 lb.	5 1/4"	3 5/16"	PGS3048ZN-TPU21(GG)
		TPU-Blue on Grey	Ball		185 lb.			PGS3048ZN-TPU21(BG)
5"	1/2" -13 x 1" #41	TPR	Nylon Ball	1 1/4"	200 lb.	6 1/4"	4 3/16"	PGS4041ZN-TPR11(GG)
		TPR	Ball		200 lb.			PGS4041ZN-TPR22(GG)
5"	1/2" -13 x 1 1/2" #48	TPU-Grey on Grey	Ball	1 1/4"	225 lb.	6 1/4"	4 3/16"	PGS4041ZN-TPU22(GG)
		TPU-Blue on Grey	Ball		225 lb.			PGS4041ZN-TPU22(BG)
5"	1/2" -13 x 1 1/2" #48	TPR	Nylon Ball	1 1/4"	200 lb.	6 1/4"	4 3/16"	PGS4048ZN-TPR11(GG)
		TPR	Ball		200 lb.			PGS4048ZN-TPR22(GG)
5"	1/2" -13 x 1 1/2" #48	TPU-Grey on Grey	Ball	1 1/4"	225 lb.	6 1/4"	4 3/16"	PGS4048ZN-TPU22(GG)
		TPU-Blue on Grey	Ball		225 lb.			PGS4048ZN-TPU22(BG)

For Tread Lock Brake add -TB to end of the part number.



Total Lock Models

Wheel Diameter	Fastening Size	Tread Material	Bearing Type	Tread Width	Dynamic Load	Mounting Height	Swivel Radius	Part Number
3"	2 ⁵ / ₈ " x 3 ³ / ₄ " (1 ³ / ₄ " x 2 ³ / ₄ "-3) #120	TPR TPR TPU-Grey on Grey TPU-Blue on Grey	Nylon Ball Ball Ball	1 ¹ / ₄ "	165 lb. 165 lb. 185 lb. 185 lb.	4 ¹ / ₄ "	4 ³ / ₈ "	PGT30120ZN-TPR11(GG) PGT30120ZN-TPR21(GG) PGT30120ZN-TPU21(GG) PGT30120ZN-TPU21(BG)
4"	2 ⁵ / ₈ " x 3 ³ / ₄ " (1 ³ / ₄ " x 2 ³ / ₄ "-3) #120	TPR TPR TPU-Grey on Grey TPU-Blue on Grey	Nylon Ball Ball Ball	1 ¹ / ₄ "	185 lb. 185 lb. 200 lb. 200 lb.	5 ¹ / ₄ "	4 ³ / ₈ "	PGT40120ZN-TPR11(GG) PGT40120ZN-TPR22(GG) PGT40120ZN-TPU22(GG) PGT40120ZN-TPU22(BG)
5"	2 ⁵ / ₈ " x 3 ³ / ₄ " (1 ³ / ₄ " x 2 ³ / ₄ "-3) #120	TPR TPR TPU-Grey on Grey TPU-Blue on Grey	Nylon Ball Ball Ball	1 ¹ / ₄ "	200 lb. 200 lb. 225 lb. 225 lb.	6 ¹ / ₄ "	4 ³ / ₈ "	PGT50120ZN-TPR11(GG) PGT50120ZN-TPR22(GG) PGT50120ZN-TPU22(GG) PGT50120ZN-TPU22(BG)



Swivel Models

Wheel Diameter	Fastening Size	Tread Material	Bearing Type	Tread Width	Dynamic Load	Mounting Height	Swivel Radius	Part Number
3"	2 ⁵ / ₈ " x 3 ³ / ₄ " (1 ³ / ₄ " x 2 ³ / ₄ "-3) #120	TPR TPR TPU-Grey on Grey TPU-Blue on Grey	Nylon Ball Ball Ball	1 ¹ / ₄ "	165 lb. 165 lb. 185 lb. 185 lb.	4 ¹ / ₄ "	2 ¹³ / ₁₆ "	PGS30120ZN-TPR11(GG) PGS30120ZN-TPR21(GG) PGS30120ZN-TPU21(GG) PGS30120ZN-TPU21(BG)
4"	2 ⁵ / ₈ " x 3 ³ / ₄ " (1 ³ / ₄ " x 2 ³ / ₄ "-3) #120	TPR TPR TPU-Grey on Grey TPU-Blue on Grey	Nylon Ball Ball Ball	1 ¹ / ₄ "	185 lb. 185 lb. 200 lb. 200 lb.	5 ¹ / ₄ "	3 ⁵ / ₁₆ "	PGS40120ZN-TPR11(GG) PGS40120ZN-TPR22(GG) PGS40120ZN-TPU22(GG) PGS40120ZN-TPU22(BG)
5"	2 ⁵ / ₈ " x 3 ³ / ₄ " (1 ³ / ₄ " x 2 ³ / ₄ "-3) #120	TPR TPR TPU-Grey on Grey TPU-Blue on Grey	Nylon Ball Ball Ball	1 ¹ / ₄ "	200 lb. 200 lb. 225 lb. 225 lb.	6 ¹ / ₄ "	4 ³ / ₁₆ "	PGS50120ZN-TPR11(GG) PGS50120ZN-TPR22(GG) PGS50120ZN-TPU22(GG) PGS50120ZN-TPU22(BG)

For Tread Lock Brake add -TB to end of the part number.



Rigid Plate Models

Wheel Diameter	Fastening Size	Tread Material	Bearing Type	Tread Width	Dynamic Load	Mounting Height	Swivel Radius	Part Number
3"	2 ⁵ / ₈ " x 3 ³ / ₄ " (1 ³ / ₄ " x 2 ³ / ₄ "-3) #120	TPR TPR TPU-Grey on Grey TPU-Blue on Grey	Nylon Ball Ball Ball	1 ¹ / ₄ "	165 lb. 165 lb. 185 lb. 185 lb.	4 ¹ / ₄ "	n/a	PGR30120ZN-TPR11(GG) PGR30120ZN-TPR21(GG) PGR30120ZN-TPU21(GG) PGR30120ZN-TPU21(BG)
4"	2 ⁵ / ₈ " x 3 ³ / ₄ " (1 ³ / ₄ " x 2 ³ / ₄ "-3) #120	TPR TPR TPU-Grey on Grey TPU-Blue on Grey	Nylon Ball Ball Ball	1 ¹ / ₄ "	185 lb. 185 lb. 200 lb. 200 lb.	5 ¹ / ₄ "	n/a	PGR40120ZN-TPR11(GG) PGR40120ZN-TPR22(GG) PGR40120ZN-TPU22(GG) PGR40120ZN-TPU22(BG)
5"	2 ⁵ / ₈ " x 3 ³ / ₄ " (1 ³ / ₄ " x 2 ³ / ₄ "-3) #120	TPR TPR TPU-Grey on Grey TPU-Blue on Grey	Nylon Ball Ball Ball	1 ¹ / ₄ "	200 lb. 200 lb. 225 lb. 225 lb.	6 ¹ / ₄ "	n/a	PGR50120ZN-TPR11(GG) PGR50120ZN-TPR22(GG) PGR50120ZN-TPU22(GG) PGR50120ZN-TPU22(BG)

Dimensions shown are approximate. Contact factory for specific dimensions.
Other fastenings and finishes may be available. Order restrictions may apply.

DOLLY CASTERS

Swivel Casters 3" and 4"

STANDARD FEATURES

- Specially constructed for heavy duty applications
- High impact Hard Rubber wheel
- 3" model features single ball raceway and riveted axle
- 4" model features dual ball raceway with nut/bolt axle
- Rigid versions available by special order

APPLICATIONS

- Material Handling
- Industrial Equipment
- Moving Dollies

3" model features single ball raceway and riveted axle



4" model features dual ball raceway with nut/bolt axle



Swivel Plates

Wheel Diameter	Fastening Size (Hole Spacing)	Tread Material	Tread Width	Dynamic Load	Mounting Height	Swivel Radius	Part Number
3"	3 ¹ / ₈ " x 4 ¹ / ₈ " (2 ³ / ₈ " x 3 ³ / ₈ " to 3 ⁷ / ₁₆ ")	High-Impact Hard Rubber	1 ¹ / ₄ "	270 lb.	3 ¹³ / ₁₆ "	2 ⁷ / ₁₆ "	PSQ3001ZN-3D
4"	3 ¹ / ₈ " x 4 ¹ / ₈ " (2 ³ / ₈ " x 3 ³ / ₈ " to 3 ⁷ / ₁₆ ")	High-Impact Hard Rubber	1 ¹ / ₄ "	275 lb.	5 ¹ / ₈ "	3 ³ / ₈ "	PGS37119ZN-3D

Dimensions shown are approximate. Contact factory for specific dimensions. Other fastenings and finishes may be available. Order restrictions may apply.

GENERAL DUTY

Swivel and Rigid Casters 2", 2½", 3", 4"



STANDARD FEATURES

- Zinc finish
- Single race
- Nut and bolt axle
- Nickel plated kingpin for smooth swivel
- Economical

APPLICATIONS

- Material Handling
- Institutional Equipment
- Industrial Equipment
- Furniture

WHEEL SELECTIONS



SOFT RUBBER [-3R]



HARD RUBBER [-3H]



POLYOLEFIN [-3E]

OPTION

BRAKE

Brake option available on swivel [SQ] models only.



Swivel Plates

Wheel Diameter	Fastening Size (Hole Spacing)	Tread Material	Tread Width	Dynamic Load	Mounting Height	Swivel Radius	Part Number
2"	1 7/8" x 2 9/16" (1 5/16" x 2 1/8") 3/8" Holes	Polyolefin Soft Rubber Hard Rubber	1 3/16"	125 lb. 90 lb. 125 lb.	2 1/2"	1 3/4"	PSQ2001ZN-3E PSQ2001ZN-3R PSQ2001ZN-3H
2 1/2"	2 3/4" x 3 7/8" (1 3/4" x 3") 3/8" Holes	Polyolefin Soft Rubber Hard Rubber	1 1/8"	175 lb. 100 lb. 175 lb.	3 1/4"	2 1/4"	PSQ2501ZN-3E PSQ2501ZN-3R PSQ2501ZN-3H
3"	3 1/8" x 4 1/8" (2 3/8" x 3 3/8" to 3 7/16") 3/8" Holes	Polyolefin Soft Rubber Hard Rubber	1 1/4"	210 lb. 150 lb. 225 lb.	3 13/16"	2 7/16"	PSQ3001ZN-3E PSQ3001ZN-3R PSQ3001ZN-3H
4"	4" x 5 1/8" (3" x 4") 3/8" Holes	Polyolefin Soft Rubber Hard Rubber	1 3/8"	250 lb. 200 lb. 300 lb.	5"	3 7/16"	PSQ4001ZN-3E PSQ4001ZN-3R PSQ4001ZN-3H

Dimensions shown are approximate. Contact factory for specific dimensions.
Other fastenings and finishes may be available. Order restrictions may apply.

GENERAL DUTY



Swivel Plates with Brake

Wheel Diameter	Fastening Size (Hole Spacing)	Tread Material	Tread Width	Dynamic Load	Mounting Height	Swivel Radius	Part Number
2"	1 ⁷ / ₈ " x 2 ³ / ₁₆ " (1 ⁵ / ₁₆ " x 2 ¹ / ₈ ") 3/8" Holes	Polyolefin Soft Rubber Hard Rubber	1 ³ / ₁₆ "	125 lb. 90 lb. 125 lb.	2 ¹ / ₂ "	2 ¹ / ₈ "	PSQ2001ZN-3EB PSQ2001ZN-3RB PSQ2001ZN-3HB
2¹/₂"	2 ³ / ₄ " x 3 ⁷ / ₈ " (1 ³ / ₄ " x 3") 3/8" Holes	Polyolefin Soft Rubber Hard Rubber	1 ¹ / ₈ "	175 lb. 100 lb. 175 lb.	3 ¹ / ₄ "	2 ³ / ₄ "	PSQ2501ZN-3EB PSQ2501ZN-3RB PSQ2501ZN-3HB
3"	3 ¹ / ₈ " x 4 ¹ / ₈ " (2 ³ / ₈ " x 3 ³ / ₈ " to 3 ⁷ / ₁₆ ") 3/8" Holes	Polyolefin Soft Rubber Hard Rubber	1 ¹ / ₄ "	210 lb. 150 lb. 225 lb.	3 ¹³ / ₁₆ "	2 ¹⁵ / ₁₆ "	PSQ3001ZN-3EB PSQ3001ZN-3RB PSQ3001ZN-3HB
4"	4" x 5 ¹ / ₈ " (3" x 4") 3/8" Holes	Polyolefin Soft Rubber Hard Rubber	1 ³ / ₈ "	250 lb. 200 lb. 300 lb.	5"	3 ⁹ / ₁₆ "	PSQ4001ZN-3EB PSQ4001ZN-3RB PSQ4001ZN-3HB



Rigid Plates

Wheel Diameter	Fastening Size (Hole Spacing)	Tread Material	Tread Width	Dynamic Load	Mounting Height	Swivel Radius	Part Number
2"	1 ¹ / ₂ " x 2 ² / ₃₂ " (1 ⁵ / ₁₆ " x 2 ¹ / ₈ ") 3/8" Holes	Polyolefin Soft Rubber Hard Rubber	1 ³ / ₁₆ "	125 lb. 90 lb. 125 lb.	2 ¹ / ₂ "	N/A	PRQ2001ZN-3E PRQ2001ZN-3R PRQ2001ZN-3H
2¹/₂"	2 ¹ / ₈ " x 4 ³ / ₈ " (1 ¹ / ₁₆ " x 3 ¹ / ₂ ") 3/8" Holes	Polyolefin Soft Rubber Hard Rubber	1 ¹ / ₈ "	175 lb. 100 lb. 175 lb.	3 ¹ / ₄ "	N/A	PRQ2501ZN-3E PRQ2501ZN-3R PRQ2501ZN-3H
3"	2 ⁵ / ₁₆ " x 4 ⁷ / ₈ " (1 ¹ / ₁₆ " x 3") 3/8" Holes	Polyolefin Soft Rubber Hard Rubber	1 ¹ / ₄ "	210 lb. 150 lb. 225 lb.	3 ¹³ / ₁₆ "	N/A	PRQ3001ZN-3E PRQ3001ZN-3R PRQ3001ZN-3H
4"	3 ¹ / ₁₆ " x 6 ¹ / ₈ " (1 ³ / ₄ " x 5") 3/8" Holes	Polyolefin Soft Rubber Hard Rubber	1 ³ / ₈ "	250 lb. 200 lb. 300 lb.	5"	N/A	PRQ4001ZN-3E PRQ4001ZN-3R PRQ4001ZN-3H

Dimensions shown are approximate. Contact factory for specific dimensions.
Other fastenings and finishes may be available. Order restrictions may apply.

PACER

Hooded Die-Cast Twin Wheel Casters 50 mm, 60 mm



STANDARD FEATURES

- Zinc die-cast body and hood
- Concealed axle
- Meets or exceeds ANSI/BIFMA standards for seating in both models

APPLICATIONS

- Seating
- Electronic Equipment
- Store Fixtures
- Office Equipment

OPTIONS

BRAKE

Brake option available on 50 mm nylon wheel only.

For brake option, insert [-B] at the end of the Part Number.



URETHANE TREAD

Urethane tread available on both sizes, non-brake models only.

For urethane tread, insert [-U] at the end of the Part Number.



FINISHES

HOOD FINISHES

Bright Chrome [BC]
 Brass Plate [BR]
 Flat Black [FB]
 Satin Chrome [SC]
 Windsor Antique [WA]

Stemless

Wheel Diameter	Fastening Size	Tread Material	Finish	Dynamic Load	Mounting Height	Swivel Radius	Part Number
50 mm	No Fastening	Nylon	Bright Chrome	75 lb.	N/A	1 ³ / ₄ " 2 ⁷ / ₁₆ " [-B]	PPA5000BC
			Brass Plate				PPA5000BR
			Flat Black				PPA5000FB
			Satin Chrome				PPA5000SC
			Windsor Antique				PPA5000WA
60 mm	No Fastening	Nylon	Bright Chrome	100 lb.	N/A	2 ³ / ₁₆ "	PPA6000BC
			Brass Plate				PPA6000BR
			Flat Black				PPA6000FB
			Satin Chrome				PPA6000SC
			Windsor Antique				PPA6000WA

Dimensions shown are approximate. Contact factory for specific dimensions.
 Other fastenings and finishes may be available. Order restrictions may apply.



Wheel Diameter	Fastening Size	Tread Material	Finish	Dynamic Load	Mounting Height	Swivel Radius	Part Number
50 mm	1/4"-20 x 5/8" #28	Nylon	Bright Chrome Brass Plate Flat Black Satin Chrome Windsor Antique	75 lb.			PPA5028BC PPA5028BR PPA5028FB PPA5028SC PPA5028WA
	5/16"-18 x 1/2" #25	Nylon	Bright Chrome Brass Plate Flat Black Satin Chrome Windsor Antique	75 lb.			PPA5025BC PPA5025BR PPA5025FB PPA5025SC PPA5025WA
	5/16"-18 x 1" #07	Nylon	Bright Chrome Brass Plate Flat Black Satin Chrome Windsor Antique	75 lb.			PPA5007BC PPA5007BR PPA5007FB PPA5007SC PPA5007WA
	3/8"-24 x 5/8" #39	Nylon	Bright Chrome Brass Plate Flat Black Satin Chrome Windsor Antique	75 lb.	2 1/2"	1 3/4" 2 7/16" [-B]	PPA5039BC PPA5039BR PPA5039FB PPA5039SC PPA5039WA
	3/8"-16 x 3/4" #37	Nylon	Bright Chrome Brass Plate Flat Black Satin Chrome Windsor Antique	75 lb.			PPA5037BC PPA5037BR PPA5037FB PPA5037SC PPA5037WA
	3/8"-16 x 1" #34	Nylon	Bright Chrome Brass Plate Flat Black Satin Chrome Windsor Antique	75 lb.			PPA5034BC PPA5034BR PPA5034FB PPA5034SC PPA5034WA
	3/8"-16 x 1 1/2" #05	Nylon	Bright Chrome Brass Plate Flat Black Satin Chrome Windsor Antique	75 lb.			PPA5005BC PPA5005BR PPA5005FB PPA5005SC PPA5005WA

Dimensions shown are approximate. Contact factory for specific dimensions.
Other fastenings and finishes may be available. Order restrictions may apply.



Threaded Stems

Wheel Diameter	Fastening Size	Tread Material	Finish	Dynamic Load	Mounting Height	Swivel Radius	Part Number
60 mm	$\frac{5}{16}$ " - 18 x $\frac{1}{2}$ " #25	Nylon	Bright Chrome Brass Plate Flat Black Satin Chrome Windsor Antique	100 lb.	$2\frac{7}{8}$ "	$2\frac{3}{16}$ "	PPA6025BC PPA6025BR PPA6025FB PPA6025SC PPA6025WA
	$\frac{5}{16}$ " - 18 x $\frac{7}{8}$ " #45	Nylon	Bright Chrome Brass Plate Flat Black Satin Chrome Windsor Antique	100 lb.			PPA6045BC PPA6045BR PPA6045FB PPA6045SC PPA6045WA
	$\frac{5}{16}$ " - 18 x $1\frac{1}{4}$ " #26	Nylon	Bright Chrome Brass Plate Flat Black Satin Chrome Windsor Antique	100 lb.			PPA6026BC PPA6026BR PPA6026FB PPA6026SC PPA6026WA
	$\frac{3}{8}$ " - 24 x $\frac{5}{8}$ " #39	Nylon	Bright Chrome Brass Plate Flat Black Satin Chrome Windsor Antique	100 lb.			PPA6039BC PPA6039BR PPA6039FB PPA6039SC PPA6039WA
	$\frac{3}{8}$ " - 16 x $\frac{3}{4}$ " #37	Nylon	Bright Chrome Brass Plate Flat Black Satin Chrome Windsor Antique	100 lb.			PPA6037BC PPA6037BR PPA6037FB PPA6037SC PPA6037WA
	$\frac{3}{8}$ " - 16 x $1\frac{1}{2}$ " #05	Nylon	Bright Chrome Brass Plate Flat Black Satin Chrome Windsor Antique	100 lb.			PPA6005BC PPA6005BR PPA6005FB PPA6005SC PPA6005WA

Plates

Wheel Diameter	Fastening Size	Tread Material	Finish	Dynamic Load	Mounting Height	Swivel Radius	Part Number
50 mm	$1\frac{3}{16}$ " x 2" #13	Nylon	Bright Chrome Brass Plate Flat Black Satin Chrome Windsor Antique	75 lb.	$2\frac{11}{16}$ "	$1\frac{3}{4}$ " $2\frac{7}{16}$ " [-B]	PPA5013BC PPA5013BR PPA5013FB PPA5013SC PPA5013WA
	1 $\frac{1}{2}$ " Square #01	Nylon	Bright Chrome Brass Plate Flat Black Satin Chrome Windsor Antique	75 lb.			PPA5001BC PPA5001BR PPA5001FB PPA5001SC PPA5001WA
60 mm	$1\frac{3}{16}$ " x 2" #13	Nylon	Bright Chrome Brass Plate Flat Black Satin Chrome Windsor Antique	100 lb.	$3\frac{1}{16}$ "	$2\frac{3}{16}$ "	PPA6013BC PPA6013BR PPA6013FB PPA6013SC PPA6013WA
	1 $\frac{1}{2}$ " Square #01	Nylon	Bright Chrome Brass Plate Flat Black Satin Chrome Windsor Antique	100 lb.			PPA6001BC PPA6001BR PPA6001FB PPA6001SC PPA6001WA

Dimensions shown are approximate. Contact factory for specific dimensions.
Other fastenings and finishes may be available. Order restrictions may apply.



Wheel Diameter	Fastening Size	Tread Material	Finish	Dynamic Load	Mounting Height	Swivel Radius	Part Number
50 mm	$\frac{5}{16}$ " x $1\frac{1}{2}$ " #02 Grip Neck	Nylon	Bright Chrome Brass Plate Flat Black Satin Chrome Windsor Antique	75 lb.	$2\frac{3}{8}$ "	$1\frac{3}{4}$ " $2\frac{7}{16}$ " [-B]	PPA5002BC PPA5002BR PPA5002FB PPA5002SC PPA5002WA
	$\frac{3}{8}$ " x 1" #87 Grip Ring	Nylon	Bright Chrome Brass Plate Flat Black Satin Chrome Windsor Antique	75 lb.			PPA5087BC PPA5087BR PPA5087FB PPA5087SC PPA5087WA
	$\frac{7}{16}$ " x $\frac{7}{8}$ " #88 Grip Ring	Nylon	Bright Chrome Brass Plate Flat Black Satin Chrome Windsor Antique	75 lb.			PPA5088BC PPA5088BR PPA5088FB PPA5088SC PPA5088WA
	$\frac{7}{16}$ " x $1\frac{1}{16}$ " #82 Grip Ring	Nylon	Bright Chrome Brass Plate Flat Black Satin Chrome Windsor Antique	75 lb.			PPA5082BC PPA5082BR PPA5082FB PPA5082SC PPA5082WA
60 mm	$\frac{5}{16}$ " x $1\frac{1}{2}$ " #02 Grip Neck	Nylon	Bright Chrome Brass Plate Flat Black Satin Chrome Windsor Antique	100 lb.	$2\frac{3}{4}$ "	$2\frac{3}{16}$ "	PPA6002BC PPA6002BR PPA6002FB PPA6002SC PPA6002WA
	$\frac{3}{8}$ " x 1" #87 Grip Ring	Nylon	Bright Chrome Brass Plate Flat Black Satin Chrome Windsor Antique	100 lb.			PPA6087BC PPA6087BR PPA6087FB PPA6087SC PPA6087WA
	$\frac{7}{16}$ " x $\frac{7}{8}$ " #88 Grip Ring	Nylon	Bright Chrome Brass Plate Flat Black Satin Chrome Windsor Antique	100 lb.			PPA6088BC PPA6088BR PPA6088FB PPA6088SC PPA6088WA
	$\frac{7}{16}$ " x $1\frac{1}{16}$ " #82 Grip Ring	Nylon	Bright Chrome Brass Plate Flat Black Satin Chrome Windsor Antique	100 lb.			PPA6082BC PPA6082BR PPA6082FB PPA6082SC PPA6082WA

TWIN WHEEL CASTERS

Dimensions shown are approximate. Contact factory for specific dimensions. Other fastenings and finishes may be available. Order restrictions may apply.

PILOT

Unhooded Die-Cast Twin Wheel Casters 50 mm, 60 mm



STANDARD FEATURES

- Zinc die-cast body
- Concealed axle
- Meets or exceeds ANSI/BIFMA standards for seating all models

APPLICATIONS

- Seating
- Electronic Equipment
- Store Fixtures

OPTION

URETHANE TREAD

Urethane tread available on both sizes.

For urethane tread option, insert [-U] at the end of the Part Number.



Stemless

Wheel Diameter	Fastening Size	Tread Material	Finish	Dynamic Load	Mounting Height	Swivel Radius	Part Number
50 mm	No Fastening	Nylon	Flat Black	75 lb.	N/A	1 ¹¹ / ₁₆ "	PPB5000FB
60 mm	No Fastening	Nylon	Flat Black	100 lb.	N/A	2 ¹ / ₁₆ "	PPB6000FB

Dimensions shown are approximate. Contact factory for specific dimensions. Other fastenings and finishes may be available. Order restrictions may apply.

Threaded Stems

Wheel Diameter	Fastening Size	Fastening Number	Tread Material	Finish	Dynamic Load	Mounting Height	Swivel Radius	Part Number
50 mm	1/4"-20 x 5/8"	#28	Nylon	Flat Black	75 lb.	2 1/2"	1 11/16"	PPB5028FB
	5/16"-18 x 1/2"	#25	Nylon	Flat Black	75 lb.			PPB5025FB
	5/16"-18 x 1"	#07	Nylon	Flat Black	75 lb.			PPB5007FB
	3/8"-24 x 5/8"	#39	Nylon	Flat Black	75 lb.			PPB5039FB
	3/8"-16 x 3/4"	#37	Nylon	Flat Black	75 lb.			PPB5037FB
	3/8"-16 x 1 1/2"	#05	Nylon	Flat Black	75 lb.			PPB5005FB
60 mm	5/16"-18 x 1/2"	#25	Nylon	Flat Black	100 lb.	2 7/8"	2 1/16"	PPB6025FB
	5/16"-18 x 7/8"	#45	Nylon	Flat Black	100 lb.			PPB6045FB
	5/16"-18 x 1 1/4"	#26	Nylon	Flat Black	100 lb.			PPB6026FB
	3/8"-24 x 5/8"	#39	Nylon	Flat Black	100 lb.			PPB6039FB
	3/8"-16 x 3/4"	#37	Nylon	Flat Black	100 lb.			PPB6037FB
	3/8"-16 x 1 1/2"	#05	Nylon	Flat Black	100 lb.			PPB6005FB

Plates

Wheel Diameter	Fastening Size	Fastening Number	Tread Material	Finish	Dynamic Load	Mounting Height	Swivel Radius	Part Number
50 mm	1 3/16" x 2"	#13	Nylon	Flat Black	75 lb.	2 11/16"	1 11/16"	PPB5013FB
	1 1/2" Square	#01	Nylon	Flat Black	75 lb.			PPB5001FB
60 mm	1 3/16" x 2"	#13	Nylon	Flat Black	100 lb.	3 1/16"	2 1/16"	PPB6013FB
	1 1/2" Square	#01	Nylon	Flat Black	100 lb.			PPB6001FB

For detailed plate information, see back of catalog.

Grip Neck and Grip Ring Stems

Wheel Diameter	Fastening Size	Fastening Number	Tread Material	Finish	Dynamic Load	Mounting Height	Swivel Radius	Part Number
50 mm	5/16" x 1 1/2"	#02 Grip Neck	Nylon	Flat Black	75 lb.	2 3/8"	1 11/16"	PPB5002FB
	3/8" x 1"	#87 Grip Ring	Nylon	Flat Black	75 lb.			PPB5087FB
	7/16" x 7/8"	#88 Grip Ring	Nylon	Flat Black	75 lb.			PPB5088FB
	7/16" x 1 1/16"	#82 Grip Ring	Nylon	Flat Black	75 lb.			PPB5082FB
60 mm	5/16" x 1 1/2"	#02 Grip Neck	Nylon	Flat Black	100 lb.	2 3/4"	2 1/16"	PPB6002FB
	3/8" x 1"	#87 Grip Ring	Nylon	Flat Black	100 lb.			PPB6087FB
	7/16" x 7/8"	#88 Grip Ring	Nylon	Flat Black	100 lb.			PPB6088FB
	7/16" x 1 1/16"	#82 Grip Ring	Nylon	Flat Black	100 lb.			PPB6082FB

Dimensions shown are approximate. Contact factory for specific dimensions. Other fastenings and finishes may be available. Order restrictions may apply.

SOURCE II

Black Nylon Hooded Twin Wheel Casters 40 mm, 50 mm, 60 mm



STANDARD FEATURES

- All nylon construction
- Steel axle and fastening
- Meets or exceeds ANSI/BIFMA standards for seating in 50 mm and 60 mm models

APPLICATIONS

- Furniture
- Display Units
- Medical Equipment
- Utility Carts
- Office Equipment

OPTION

BRAKE

Brake option available on all models.

For brake option, insert [-B] at the end of the Part Number.



Threaded Stems

Wheel Diameter	Fastening Size	Fastening Number	Tread Material	Finish	Dynamic Load	Mounting Height	Swivel Radius	Part Number
40 mm	5/16" -18 x 1"	#07	Nylon	Black	40lb.	2"	1 11/16"	PTW4007BK
	3/8" -16 x 3/4"	#37	Nylon	Black	40lb.		1 15/16" [-B]	PTW4037BK
50 mm	5/16" -18 x 1"	#07	Nylon	Black	75 lb.	2 3/8"	2"	PTW5007BK
	3/8" -16 x 3/4"	#37	Nylon	Black	75 lb.		2 7/16" [-B]	PTW5037BK
60 mm	5/16" -18 x 1"	#07	Nylon	Black	100 lb.	2 3/4"	2 1/4"	PTW6007BK
	3/8" -16 x 3/4"	#37	Nylon	Black	100 lb.		2 7/16" [-B]	PTW6037BK

Plates

Wheel Diameter	Fastening Size	Fastening Number	Tread Material	Finish	Dynamic Load	Mounting Height	Swivel Radius	Part Number
40 mm	1 3/16" x 2"	#13	Nylon	Black	40 lb.	2 1/4"	1 11/16"	PTW4013BK
	1 1/2" Square	#01	Nylon	Black	40 lb.		1 15/16" [-B]	PTW4001BK
50 mm	1 3/16" x 2"	#13	Nylon	Black	75 lb.	2 5/8"	2"	PTW5013BK
	1 1/2" Square	#01	Nylon	Black	75 lb.		2 7/16" [-B]	PTW5001BK
60 mm	1 3/16" x 2"	#13	Nylon	Black	100 lb.	3"	2 1/4"	PTW6013BK
	1 1/2" Square	#01	Nylon	Black	100 lb.		2 7/16" [-B]	PTW6001BK

For detailed plate information, see back of catalog.

Grip Neck and Grip Ring Stems

Wheel Diameter	Fastening Size	Fastening Number	Tread Material	Finish	Dynamic Load	Mounting Height	Swivel Radius	Part Number
40 mm	5/16" x 1 1/2"	#02 Grip Neck	Nylon	Black	40 lb.	2"	1 11/16"	PTW4002BK
	7/16" x 7/8"	#88 Grip Ring	Nylon	Black	40 lb.		1 15/16" [-B]	PTW4088BK
50 mm	5/16" x 1 1/2"	#02 Grip Neck	Nylon	Black	75 lb.	2 3/8"	2" 2 7/16" [-B]	PTW5002BK
	3/8" x 1"	#87 Grip Ring	Nylon	Black	75 lb.			PTW5087BK
	7/16" x 7/8"	#88 Grip Ring	Nylon	Black	75 lb.			PTW5088BK
	7/16" x 1 1/16"	#82 Grip Ring	Nylon	Black	75 lb.			PTW5082BK
60 mm	5/16" x 1 1/2"	#02 Grip Neck	Nylon	Black	100 lb.	2 3/4"	2 1/4" 2 7/16" [-B]	PTW6002BK
	7/16" x 7/8"	#88 Grip Ring	Nylon	Black	100 lb.			PTW6088BK
	7/16" x 1 1/16"	#82 Grip Ring	Nylon	Black	100 lb.			PTW6082BK

Dimensions shown are approximate. Contact factory for specific dimensions.
Other fastenings and finishes may be available. Order restrictions may apply.

SOURCE II UNHOODED

Black Nylon or Urethane Tread Unhooded Twin Wheel Casters
50 mm, 60 mm



STANDARD FEATURES

- Nylon or Urethane Tread
- Steel axle and fastening
- Available separately as stem and body

APPLICATIONS

- Furniture
- Store Fixtures
- Medical Equipment
- Office Equipment

OPTION

BRAKE

Brake option available on all models.



For brake option, insert [-B] for nylon tread or [-BU] for urethane tread at the end of the part number.

No Fastenings



Wheel Diameter	Fastening Size	Tread Material	Finish	Dynamic Load	Mounting Height	Swivel Radius	Part Number
50 mm	None	Nylon	Black	75 lb.	N/A	1 ¹³ / ₁₆ "	PUT5000BK
	None	Urethane	Black	75 lb.			PUT5000BK-U
60 mm	None	Nylon	Black	100 lb.	N/A	2 ¹ / ₁₆ "	PUT6000BK
	None	Urethane	Black	100 lb.			PUT6000BK-U

Threaded Stems



Wheel Diameter	Fastening Size	Tread Material	Finish	Dynamic Load	Mounting Height	Swivel Radius	Part Number
50 mm	5/16"-18 x 1" #07	Nylon Urethane	Black Black	75 lb. 75 lb.	2 ¹ / ₄ "	1 ¹³ / ₁₆ "	PUT5007BK PUT5007BK-U
	3/8"-16 x 3/4" #37	Nylon Urethane	Black Black	75 lb. 75 lb.			PUT5037BK PUT5037BK-U
	3/8"-16 x 1" #34	Nylon Urethane	Black Black	75 lb. 75 lb.			PUT5034BK PUT5034BK-U
60 mm	5/16"-18 x 1" #07	Nylon Urethane	Black Black	100 lb. 100 lb.	2 ⁵ / ₈ "	2 ¹ / ₁₆ "	PUT6007BK PUT6007BK-U
	3/8"-16 x 3/4" #37	Nylon Urethane	Black Black	100 lb. 100 lb.			PUT6037BK PUT6037BK-U
	3/8"-16 x 1" #34	Nylon Urethane	Black Black	100 lb. 100 lb.			PUT6034BK PUT6034BK-U

Dimensions shown are approximate. Contact factory for specific dimensions. Other fastenings and finishes may be available. Order restrictions may apply.

SOURCE II UNHOODED



Plates

Wheel Diameter	Fastening Size	Tread Material	Finish	Dynamic Load	Mounting Height	Swivel Radius	Part Number
50 mm	1/2"-Square #01	Nylon Urethane	Black Black	75 lb.	2 ³ / ₈ "	1 ¹³ / ₁₆ "	PUT5001BK PUT5001BK-U
				75 lb.			
60 mm	1/2"-Square #01	Nylon Urethane	Black Black	100 lb. 100 lb.	2 ³ / ₄ "	2 ³ / ₄ "	PUT6001BK PUT6001BK-U



Grip Neck, Grip Ring, Grip Band Stems

Wheel Diameter	Fastening Size	Tread Material	Finish	Dynamic Load	Mounting Height	Swivel Radius	Part Number
50 mm	5/16" x 1 1/2" #02 Grip Neck	Nylon Urethane	Black Black	75 lb.	2 1/4"	1 13/16"	PUT5002BK PUT5002BK-U
				75 lb.			
				75 lb.			
				75 lb.			
60 mm	5/16" x 1 1/2" #02 Grip Neck	Nylon Urethane	Black Black	100 lb.	2 5/8"	2 1/16"	PUT6002BK PUT6002BK-U
				100 lb.			
				100 lb.			
				100 lb.			
50 mm	7/16" x 7/8" #88 Grip Ring	Nylon Urethane	Black Black	75 lb.	2 1/4"	1 13/16"	PUT5088BK PUT5088BK-U
				75 lb.			
				75 lb.			
				75 lb.			
60 mm	7/16" x 7/8" #88 Grip Ring	Nylon Urethane	Black Black	100 lb.	2 5/8"	2 1/16"	PUT6088BK PUT6088BK-U
				100 lb.			
				100 lb.			
				100 lb.			
50 mm	7/16" x 1 7/16" #82 Grip Ring	Nylon Urethane	Black Black	75 lb.	2 1/4"	1 13/16"	PUT5082BK PUT5082BK-U
				75 lb.			
				75 lb.			
				75 lb.			
60 mm	7/16" x 1 7/16" #82 Grip Ring	Nylon Urethane	Black Black	100 lb.	2 5/8"	2 1/16"	PUT6082BK PUT6082BK-U
				100 lb.			
				100 lb.			
				100 lb.			
50 mm	7/16" x 1 7/16" #73 Brass Band	Nylon Urethane	Black Black	75 lb.	2 1/4"	1 13/16"	PUT5073BK PUT5073BK-U
				75 lb.			
				75 lb.			
				75 lb.			
60 mm	7/16" x 1 7/16" #73 Brass Band	Nylon Urethane	Black Black	100 lb.	2 5/8"	2 1/16"	PUT6073BK PUT6073BK-U
				100 lb.			
				100 lb.			
				100 lb.			

PERT

Nylon Hooded Twin Wheel Casters 52 mm



STANDARD FEATURES

- Domestic made product
- All nylon construction
- Meets or exceeds ANSI/BIFMA standards for seating

APPLICATIONS

- Seating
- Utility Carts
- Appliances

OPTION

BRAKE

Brake option available in black hood only.

For brake option, insert [-B] at the end of the Part Number.



Stemless

Wheel Diameter	Fastening Size	Tread Material	Finish	Dynamic Load	Mounting Height	Swivel Radius	Part Number
52 mm	No Fastening	Nylon	Black	75 lb.	N/A	1 ¹³ / ₁₆ " 2 ⁹ / ₁₆ " [-B]	PPE5200BK
			Bright Brass				PPE5200BB
			Bright Chrome				PPE5200BC
			Windsor Antique				PPE5200WA

Threaded Stems

Wheel Diameter	Fastening Size	Tread Material	Finish	Dynamic Load	Mounting Height	Swivel Radius	Part Number
52 mm	1/4"-20 x 5/8" #28	Nylon	Black	75 lb.			PPE5228BK
			Bright Brass				PPE5228BB
			Bright Chrome				PPE5228BC
			Windsor Antique				PPE5228WA
	5/16"-18 x 1/2" #25	Nylon	Black	75 lb.			PPE5225BK
Bright Brass			PPE5225BB				
Bright Chrome			PPE5225BC				
Windsor Antique			PPE5225WA				
5/16"-18 x 1" #07			Nylon				Black
	Bright Brass	PPE5207BB					
	Bright Chrome	PPE5207BC					
	Windsor Antique	PPE5207WA					
	3/8"-16 x 3/4" #37	Nylon		Black	75 lb.		
Bright Brass			PPE5237BB				
Bright Chrome			PPE5237BC				
Windsor Antique			PPE5237WA				
3/8"-16 x 1 1/2" #05			Nylon	Black			
	Bright Brass	PPE5205BB					
	Bright Chrome	PPE5205BC					
	Windsor Antique	PPE5205WA					

Dimensions shown are approximate. Contact factory for specific dimensions.
Other fastenings and finishes may be available. Order restrictions may apply.



Plates

Wheel Diameter	Fastening Size	Tread Material	Finish	Dynamic Load	Mounting Height	Swivel Radius	Part Number
52 mm	1 ³ / ₁₆ " x 2" #13	Nylon	Black Bright Brass Bright Chrome Windsor Antique	75 lb.	2 ³ / ₄ "	1 ¹³ / ₁₆ " 2 ⁹ / ₁₆ " [-B]	PPE5213BK PPE5213BB PPE5213BC PPE5213WA
	1 ¹ / ₂ " Square #01	Nylon	Black Bright Brass Bright Chrome Windsor Antique	75 lb.			PPE5201BK PPE5201BB PPE5201BC PPE5201WA

For detailed plate information, see back of catalog.



Grip Neck and Grip Ring Stems

Wheel Diameter	Fastening Size	Tread Material	Finish	Dynamic Load	Mounting Height	Swivel Radius	Part Number
52 mm	5 ¹ / ₁₆ " x 1 ¹ / ₂ " #02 Grip Neck	Nylon	Black Bright Brass Bright Chrome Windsor Antique	75 lb.	2 ⁷ / ₁₆ "	1 ¹³ / ₁₆ " 2 ⁹ / ₁₆ " [-B]	PPE5202BK PPE5202BB PPE5202BC PPE5202WA
	3 ³ / ₈ " x 1" #87 Grip Ring	Nylon	Black Bright Brass Bright Chrome Windsor Antique	75 lb.			PPE5287BK PPE5287BB PPE5287BC PPE5287WA
	7 ¹ / ₁₆ " x 7 ⁷ / ₈ " #88 Grip Ring	Nylon	Black Bright Brass Bright Chrome Windsor Antique	75 lb.			PPE5288BK PPE5288BB PPE5288BC PPE5288WA
	7 ¹ / ₁₆ " x 1 ⁷ / ₁₆ " #82 Grip Ring	Nylon	Black Bright Brass Bright Chrome Windsor Antique	75 lb.			PPE5282BK PPE5282BB PPE5282BC PPE5282WA

Dimensions shown are approximate. Contact factory for specific dimensions.
Other fastenings and finishes may be available. Order restrictions may apply.

REPLACEMENT CHAIR CASTERS

Nylon Hooded Twin Wheel Casters 55 mm



STANDARD FEATURES

- Constructed of injection-molded engineering grade nylon
- Nylon tread for carpeting and urethane for hard floors

APPLICATIONS

- Seating
- Medical Equipment

Grip Ring Stems

Wheel Diameter	Pivot Boss Diameter	Fastening Size	Tread Material	Load Rating	Mounting Height	Swivel Radius	Part Number
55 mm	1 1/2" Pivot Boss	7/16" X 7/8" #58	Nylon	75 lb.	2 1/4"	2 9/16"	PHT5558BK-02532
	1 3/4" Pivot Boss	7/16" X 7/8" #58	Nylon	75 lb.	2 1/8"		PHG5558BK-02532
	1 1/2" Pivot Boss	7/16" X 7/8" #58	Urethane	75 lb.	2 1/4"		PHT5558BK-02524
	1 3/4" Pivot Boss	7/16" X 7/8" #58	Urethane	75 lb.	2 1/8"		PHG5558BK-02524

Dimensions shown are approximate. Contact factory for specific dimensions.
Other fastenings and finishes may be available. Order restrictions may apply.

INNOVATOR

Nylon Hooded Twin Wheel Casters 60 mm



STANDARD FEATURES

- Nylon body construction
- Steel axle and fastening
- Meets or exceeds ANSI/BIFMA standards for seating

APPLICATIONS

- Seating
- Utility Carts
- Appliances

OPTION

URETHANE TREAD

Urethane tread available on all models.

For urethane tread, insert [-U] at the end of the Part Number.



Stainless

Wheel Diameter	Fastening Size	Tread Material	Finish	Dynamic Load	Mounting Height	Swivel Radius	Part Number
60 mm	No Fastening	Nylon	Black	100 lb.	N/A	1 ¹⁵ / ₁₆ "	PPI6000BK
			Bright Brass				PPI6000BB
			Bright Chrome				PPI6000BC
			Windsor Antique				PPI6000WA

Threaded Stems

Wheel Diameter	Fastening Size	Tread Material	Finish	Dynamic Load	Mounting Height	Swivel Radius	Part Number
60 mm	5/16"-18 x 1/2" #25	Nylon	Black	100 lb.	2 ⁷ / ₈ "	1 ¹⁵ / ₁₆ "	PPI6025BK
			Bright Brass				PPI6025BB
	Bright Chrome	PPI6025BC					
	Windsor Antique	PPI6025WA					
	5/16"-18 x 7/8" #45	Nylon	Black	100 lb.			PPI6045BK
			Bright Brass				PPI6045BB
	Bright Chrome	PPI6045BC					
	Windsor Antique	PPI6045WA					
	5/16"-18 x 1 1/4" #26	Nylon	Black	100 lb.			PPI6026BK
			Bright Brass				PPI6026BB
Bright Chrome	PPI6026BC						
Windsor Antique	PPI6026WA						
3/8"-16 x 3/4" #37	Nylon	Black	100 lb.	PPI6037BK			
		Bright Brass		PPI6037BB			
Bright Chrome	PPI6037BC						
Windsor Antique	PPI6037WA						
3/8"-16 x 1 1/2" #05	Nylon	Black	100 lb.	PPI6005BK			
		Bright Brass		PPI6005BB			
Bright Chrome	PPI6005BC						
Windsor Antique	PPI6005WA						

Dimensions shown are approximate. Contact factory for specific dimensions.
Other fastenings and finishes may be available. Order restrictions may apply.



Plates

Wheel Diameter	Fastening Size	Tread Material	Finish	Dynamic Load	Mounting Height	Swivel Radius	Part Number
60 mm	1 ³ / ₁₆ " x 2" #13	Nylon	Black Bright Brass Bright Chrome Windsor Antique	100 lb.	3 ³ / ₁₆ "	1 ¹⁵ / ₁₆ "	PPI6013BK PPI6013BB PPI6013BC PPI6013WA
	1 ¹ / ₂ " Square #01	Nylon	Black Bright Brass Bright Chrome Windsor Antique	100 lb.			PPI6001BK PPI6001BB PPI6001BC PPI6001WA

For detailed plate information, see back of catalog.



Grip Neck and Grip Ring Stems

Wheel Diameter	Fastening Size	Tread Material	Finish	Dynamic Load	Mounting Height	Swivel Radius	Part Number
60 mm	5 ⁵ / ₁₆ " x 1 ¹ / ₂ " #02 Grip Neck	Nylon	Black Bright Brass Bright Chrome Windsor Antique	100 lb.	2 ⁷ / ₈ "	1 ¹⁵ / ₁₆ "	PPI6002BK PPI6002BB PPI6002BC PPI6002WA
	3 ³ / ₈ " x 1" #87 Grip Ring	Nylon	Black Bright Brass Bright Chrome Windsor Antique	100 lb.			PPI6087BK PPI6087BB PPI6087BC PPI6087WA
	7 ¹ / ₁₆ " x 7 ⁷ / ₈ " #88 Grip Ring	Nylon	Black Bright Brass Bright Chrome Windsor Antique	100 lb.			PPI6088BK PPI6088BB PPI6088BC PPI6088WA
	7 ¹ / ₁₆ " x 1 ⁷ / ₁₆ " #82 Grip Ring	Nylon	Black Bright Brass Bright Chrome Windsor Antique	100 lb.			PPI6082BK PPI6082BB PPI6082BC PPI6082WA

Dimensions shown are approximate. Contact factory for specific dimensions.
Other fastenings and finishes may be available. Order restrictions may apply.

PRIM

Unhooded Nylon Twin Wheel Casters 60 mm



STANDARD FEATURES

- All nylon construction
- Steel axle and fastening
- Meets or exceeds ANSI/BIFMA standards for seating

APPLICATIONS

- Seating
- Furniture
- Store Fixtures
- Utility Carts

OPTIONS

BRAKE

Brake option available on nylon models only.
For brake option, insert [-B] at the end of the Part Number.



URETHANE TREAD

Urethane tread available on all models.
For urethane tread, insert [-U] at the end of the Part Number.

Stemless

Wheel Diameter	Fastening Size	Tread Material	Finish	Dynamic Load	Mounting Height	Swivel Radius	Part Number
60 mm	No Fastening	Nylon	Black	100 lb.	N/A	2" 2 ¹ / ₁₆ " [-B]	PPT6000BK

Threaded Stems

Wheel Diameter	Fastening Size	Tread Material	Finish	Dynamic Load	Mounting Height	Swivel Radius	Part Number
60 mm	⁵ / ₁₆ "-18 x ⁷ / ₈ " #45	Nylon	Black	100 lb.	2 ⁷ / ₈ "	2" 2 ¹ / ₁₆ " [-B]	PPT6045BK
	⁵ / ₁₆ "-18 x 1 ¹ / ₄ " #26	Nylon	Black	100 lb.			PPT6026BK
	³ / ₈ "-16 x ³ / ₄ " #37	Nylon	Black	100 lb.			PPT6037BK
	³ / ₈ "-16 x 1 ¹ / ₂ " #05	Nylon	Black	100 lb.			PPT6005BK

Plates

Wheel Diameter	Fastening Size	Tread Material	Finish	Dynamic Load	Mounting Height	Swivel Radius	Part Number
60 mm	1 ³ / ₁₆ " x 2" #13	Nylon	Black	100 lb.	3 ³ / ₁₆ "	2" 2 ¹ / ₁₆ " [-B]	PPT6013BK
	1 ¹ / ₂ " Square #01	Nylon	Black	100 lb.			PPT6001BK

For detailed plate information, see back of catalog.

Grip Neck and Grip Ring Stems

Wheel Diameter	Fastening Size	Tread Material	Finish	Dynamic Load	Mounting Height	Swivel Radius	Part Number
60 mm	⁵ / ₁₆ " x 1 ¹ / ₂ " #02 Grip Neck	Nylon	Black	100 lb.	2 ³ / ₄ "	2" 2 ¹ / ₁₆ " [-B]	PPT6002BK
	³ / ₈ " x 1" #87 Grip Ring	Nylon	Black	100 lb.			PPT6087BK
	⁷ / ₁₆ " x ⁷ / ₈ " #88 Grip Ring	Nylon	Black	100 lb.			PPT6088BK
	⁷ / ₁₆ " x 1 ⁷ / ₁₆ " #82 Grip Ring	Nylon	Black	100 lb.			PPT6082BK

Dimensions shown are approximate. Contact factory for specific dimensions.
Other fastenings and finishes may be available. Order restrictions may apply.

HEAVY DUTY

Heavy Duty Twin Wheels 40 mm, 50 mm



Available by Special Order Only. Minimum Order May Apply.

APPLICATIONS

- Computer Stands
- Electronic Equipment
- Business Machines
- Utility Carts

STANDARD FEATURES

- Rivet axle for positive wheel retention
- Through stem system increases load capacity
- Available with various fastenings
- Hub on 40 mm is bright chrome
- Great for high-impact applications

OPTION

BRAKE

Brake option available on all models.



EURO-ULTIMA

Hooded Large Twin Wheel Casters 3"



Available by Special Order Only. Minimum Order May Apply.

APPLICATIONS

- Furniture
- Medical Equipment
- Utility Carts
- Store Fixtures

STANDARD FEATURES

- Available with all standard Ultima II 75 mm fastenings
- Barrell diameter of 2" easily fits with 2" table or chair leg
- Contemporary design

OPTIONS

BRAKE

Brake option available.

URETHANE TREAD

Urethane tread available.



ULTIMA II

Large Twin Wheel Casters 3", 4", 5"



STANDARD FEATURES

- Contemporary design
- Strong nylon construction
- Rivet axle for positive wheel retention

APPLICATIONS

- Medical Equipment
- Utility Carts
- Store Fixtures
- Furniture

OPTIONS

BRAKE

Brake option available on all models.

For brake option, insert [-B] at the end of the Part Number.



URETHANE TREAD

Urethane tread available.



COLORS

Custom colors available with minimum order.



Threaded Stems

Wheel Diameter	Fastening Size	Tread Material	Dynamic Load	Mounting Height	Swivel Radius	Part Number
3" 75 mm	$\frac{5}{16}$ "-18 x 1" #07	Nylon Urethane	165 lb.	3 $\frac{1}{4}$ "	2 $\frac{1}{2}$ " 3 $\frac{3}{16}$ " [-B]	PUT7507BK PUT7507BK-U
	$\frac{3}{8}$ "-16 x $\frac{3}{4}$ " #37	Nylon Urethane	165 lb.			PUT7537BK PUT7537BK-U
	$\frac{3}{8}$ "-16 x 1" #34	Nylon Urethane	165 lb.			PUT7534BK PUT7534BK-U
	$\frac{1}{2}$ "-13 x 1" #41	Nylon Urethane	165 lb.			PUT7541BK PUT7541BK-U
	$\frac{1}{2}$ "-13 x 1 $\frac{1}{2}$ " #48	Nylon Urethane	165 lb.			PUT7548BK PUT7548BK-U
4" 100 mm	$\frac{3}{8}$ "-16 x $\frac{3}{4}$ " #37	Nylon Urethane	175 lb.	4 $\frac{3}{8}$ "	3 $\frac{5}{8}$ " 4 $\frac{1}{2}$ " [-B]	PUT10037BK PUT10037BK-U
	$\frac{3}{8}$ "-16 x 1" #34	Nylon Urethane	175 lb.			PUT10034BK PUT10034BK-U
	$\frac{1}{2}$ "-13 x 1" #41	Nylon Urethane	175 lb.			PUT10041BK PUT10041BK-U
	$\frac{1}{2}$ "-13 x 1 $\frac{1}{2}$ " #48	Nylon Urethane	175 lb.			PUT10048BK PUT10048BK-U
5" 125 mm	$\frac{1}{2}$ "-13 x 1" #41	Nylon Urethane	180 lb.	5 $\frac{7}{16}$ "	4 $\frac{1}{2}$ " 5 $\frac{1}{8}$ " [-B]	PUT12541BK PUT12541BK-U
	$\frac{1}{2}$ "-13 x 1 $\frac{1}{2}$ " #48	Nylon Urethane	180 lb.			PUT12548BK PUT12548BK-U

Dimensions shown are approximate. Contact factory for specific dimensions.
Other fastenings and finishes may be available. Order restrictions may apply.



Plates

Wheel Diameter	Fastening Size	Tread Material	Dynamic Load	Mounting Height	Swivel Radius	Part Number
3" 75 mm	1½" Square #01	Nylon Urethane	165 lb.	3½"	2½" 3¾" [-B]	PUT7501BK PUT7501BK-U
	2¾" x 2¾" #16	Nylon Urethane	165 lb.			PUT7516BK PUT7516BK-U
	2⅝" x 3¾" #120	Nylon Urethane	165 lb.			PUT75120BK PUT75120BK-U
4" 100 mm	2¾" x 2¾" #16	Nylon Urethane	175 lb.	4⅝"	3⅝" 4½" [-B]	PUT10016BK PUT10016BK-U
	2⅝" x 3¾" #120	Nylon Urethane	175 lb.			PUT100120BK PUT100120BK-U
5" 125 mm	2¾" x 2¾" #16	Nylon Urethane	180 lb.	5⅝"	4½" 5⅝" [-B]	PUT12516BK PUT12516BK-U
	2⅝" x 3¾" #120	Nylon Urethane	180 lb.			PUT125120BK PUT125120BK-U

For detailed plate information, see back of catalog.



Grip Neck and Grip Ring Stems

Wheel Diameter	Fastening Size	Tread Material	Dynamic Load	Mounting Height	Swivel Radius	Part Number
3" 75 mm	⅝" x 1½" #02 Grip Neck	Nylon Urethane	165 lb.	3¾"	2½" 3¾" [-B]	PUT7502BK PUT7502BK-U
	⅞" x ⅞" #88 Grip Ring	Nylon Urethane	165 lb.			PUT7588BK PUT7588BK-U
	⅞" x 1¼" #91 Grip Ring	Nylon Urethane	165 lb.			PUT7591BK PUT7591BK-U
	⅞" x 1⅞" #82 Grip Ring	Nylon Urethane	165 lb.			PUT7582BK PUT7582BK-U
	⅞" x 1⅞" #42 Grip Ring	Nylon Urethane	165 lb.			PUT7542BK PUT7542BK-U
4" 100 mm	⅞" x 1¼" #91 Grip Ring	Nylon Urethane	175 lb.	4⅝"	3⅝" 4½" [-B]	PUT10091BK PUT10091BK-U
	⅞" x 1⅞" #82 Grip Ring	Nylon Urethane	175 lb.			PUT10082BK PUT10082BK-U
5" 125 mm	⅞" x 1¼" #91 Grip Ring	Nylon Urethane	180 lb.	5⅝"	4½" 5⅝" [-B]	PUT12591BK PUT12591BK-U
	⅞" x 1⅞" #82 Grip Ring	Nylon Urethane	180 lb.			PUT12582BK PUT12582BK-U

Dimensions shown are approximate. Contact factory for specific dimensions.
Other fastenings and finishes may be available. Order restrictions may apply.

SOFTECH

Soft Tread Twin Wheel Casters 3", 4", 5"



STANDARD FEATURES

- Soft 70-75/A durometer tread constructed of high-tech thermoplastic elastomer
- High load ratings
- Quiet mobility

APPLICATIONS

- Electronic Equipment
- Medical Equipment
- Audio/Visual Equipment
- Furniture

OPTION

BRAKE

Brake option available on all models.

For brake option, insert [-B] at the end of the Part Number.



Threaded Stems

Wheel Diameter	Fastening Size	Tread Material	Wheel Color	Dynamic Load	Mounting Height	Swivel Radius	Part Number
3" 75 mm	5/16"-18 x 1" #07	Thermoplastic Elastomer	Black/Black Tread Light Grey/Dark Grey Tread	165 lb. 165 lb.	3 1/4"	2 1/2" 3 3/16" [-B]	PSF7507BK PSF7507GR
	3/8"-16 x 3/4" #37	Thermoplastic Elastomer	Black/Black Tread Light Grey/Dark Grey Tread	165 lb. 165 lb.			PSF7537BK PSF7537GR
	3/8"-16 x 1" #34	Thermoplastic Elastomer	Black/Black Tread Light Grey/Dark Grey Tread	165 lb. 165 lb.			PSF7534BK PSF7534GR
	1/2"-13 x 1" #41	Thermoplastic Elastomer	Black/Black Tread Light Grey/Dark Grey Tread	165 lb. 165 lb.			PSF7541BK PSF7541GR
	1/2"-13 x 1 1/2" #48	Thermoplastic Elastomer	Black/Black Tread Light Grey/Dark Grey Tread	165 lb. 165 lb.			PSF7548BK PSF7548GR
4" 100 mm	3/8"-16 x 3/4" #37	Thermoplastic Elastomer	Black/Black Tread Light Grey/Dark Grey Tread	225 lb. 225 lb.	4 3/8"	3 5/8" 4 1/2" [-B]	PSF10037BK PSF10037GR
	3/8"-16 x 1" #34	Thermoplastic Elastomer	Black/Black Tread Light Grey/Dark Grey Tread	225 lb. 225 lb.			PSF10034BK PSF10034GR
	1/2"-13 x 1" #41	Thermoplastic Elastomer	Black/Black Tread Light Grey/Dark Grey Tread	225 lb. 225 lb.			PSF10041BK PSF10041GR
	1/2"-13 x 1 1/2" #48	Thermoplastic Elastomer	Black/Black Tread Light Grey/Dark Grey Tread	225 lb. 225 lb.			PSF10048BK PSF10048GR
5" 125 mm	1/2"-13 x 1" #41	Thermoplastic Elastomer	Black/Black Tread Light Grey/Dark Grey Tread	225 lb. 225 lb.	5 7/16"	4 1/2" 5 1/8" [-B]	PSF12541BK PSF12541GR
	1/2"-13 x 1 1/2" #48	Thermoplastic Elastomer	Black/Black Tread Light Grey/Dark Grey Tread	225 lb. 225 lb.			PSF12548BK PSF12548GR

Dimensions shown are approximate. Contact factory for specific dimensions.
Other fastenings and finishes may be available. Order restrictions may apply.



Plates

Wheel Diameter	Fastening Size	Tread Material	Wheel Color	Dynamic Load	Mounting Height	Swivel Radius	Part Number
3" 75 mm	1½" Square #01	Thermoplastic Elastomer	Black/Black Tread Light Grey/Dark Grey Tread	165 lb. 165 lb.	3½"	2½" 3⅜" [-B]	PSF7501BK PSF7501GR
	2⅜" x 2⅞" #16	Thermoplastic Elastomer	Black/Black Tread Light Grey/Dark Grey Tread	165 lb. 165 lb.			PSF7516BK PSF7516GR
	2⅝" x 3¼" #120	Thermoplastic Elastomer	Black/Black Tread Light Grey/Dark Grey Tread	165 lb. 165 lb.			PSF75120BK PSF75120GR
4" 100 mm	2⅜" x 2⅞" #16	Thermoplastic Elastomer	Black/Black Tread Light Grey/Dark Grey Tread	225 lb. 225 lb.	4⅝"	3⅝" 4½" [-B]	PSF10016BK PSF10016GR
	2⅝" x 3¼" #120	Thermoplastic Elastomer	Black/Black Tread Light Grey/Dark Grey Tread	225 lb. 225 lb.			PSF100120BK PSF100120GR
5" 125 mm	2⅜" x 2⅞" #16	Thermoplastic Elastomer	Black/Black Tread Light Grey/Dark Grey Tread	225 lb. 225 lb.	5⅝"	4½" 5⅞" [-B]	PSF12516BK PSF12516GR
	2⅝" x 3¼" #120	Thermoplastic Elastomer	Black/Black Tread Light Grey/Dark Grey Tread	225 lb. 225 lb.			PSF125120BK PSF125120GR

For detailed plate information, see back of catalog.



Grip Neck and Grip Ring Stems

Wheel Diameter	Fastening Size	Tread Material	Wheel Color	Dynamic Load	Mounting Height	Swivel Radius	Part Number
3" 75 mm	⅝" x 1½" #02 Grip Neck	Thermoplastic Elastomer	Black/Black Tread Light Grey/Dark Grey Tread	165 lb. 165 lb.	3⅜"	2½" 3⅜" [-B]	PSF7502BK PSF7502GR
	⅞" x ⅞" #88 Grip Ring	Thermoplastic Elastomer	Black/Black Tread Light Grey/Dark Grey Tread	165 lb. 165 lb.			PSF7588BK PSF7588GR
	⅞" x 1¼" #91 Grip Ring	Thermoplastic Elastomer	Black/Black Tread Light Grey/Dark Grey Tread	165 lb. 165 lb.			PSF7591BK PSF7591GR
	⅞" x 1⅞" #82 Grip Ring	Thermoplastic Elastomer	Black/Black Tread Light Grey/Dark Grey Tread	165 lb. 165 lb.			PSF7582BK PSF7582GR
	⅞" x 1⅞" #42 Grip Ring	Thermoplastic Elastomer	Black/Black Tread Light Grey/Dark Grey Tread	165 lb. 165 lb.			PSF7542BK PSF7542GR
4" 100 mm	⅞" x 1¼" #91 Grip Ring	Thermoplastic Elastomer	Black/Black Tread Light Grey/Dark Grey Tread	225 lb. 225 lb.	4⅝"	3⅝" 4½" [-B]	PSF10091BK PSF10091GR
	⅞" x 1⅞" #82 Grip Ring	Thermoplastic Elastomer	Black/Black Tread Light Grey/Dark Grey Tread	225 lb. 225 lb.			PSF10082BK PSF10082GR
5" 125 mm	⅞" x 1¼" #91 Grip Ring	Thermoplastic Elastomer	Black/Black Tread Light Grey/Dark Grey Tread	225 lb. 225 lb.	5⅝"	4½" 5⅞" [-B]	PSF12591BK PSF12591GR
	⅞" x 1⅞" #82 Grip Ring	Thermoplastic Elastomer	Black/Black Tread Light Grey/Dark Grey Tread	225 lb. 225 lb.			PSF12582BK PSF12582GR

Dimensions shown are approximate. Contact factory for specific dimensions.
Other fastenings and finishes may be available. Order restrictions may apply.

TRAVELAID

Soft Tread Twin Wheel Casters 4½", 5"



STANDARD FEATURES

- Soft rubber tread
- Constructed of high-impact, corrosion-resistant nylon

APPLICATIONS

- Medical Equipment
- Audio/Visual Carts
- Store Fixtures

OPTIONS

BUTTON BRAKE

Brake option available on all models.

For brake option, insert [-B] at the end of the Part Number.



BRAKE INDICATOR

Brake indicator available on all models.

For brake indicator option, insert [-BI] at the end of the Part Number.



FIXED

Fixed (non-swivel) available on all models.

For fixed caster option, insert [-F] at the end of the Part Number.



CONDUCTIVE TREAD

Conductive tread option available on all black models. For conductive tread (black tread only), insert [-C] at the end of the Part Number. Conductive treads are not U.L. approved. Conductivity is not guaranteed.

Threaded Stems

Wheel Diameter	Fastening Size	Tread Material	Finish	Dynamic Load	Mounting Height	Swivel Radius	Part Number
4½"	⅜"-16 x ¾" #37	Rubber	Black Gray	132 lb.	5⅞"	3 ¹⁷ / ₃₂ " 3 ⁷ / ₈ " [-B]	PTA4537BK PTA4537GR
	½"-13 x 1" #41	Rubber	Black Gray	132 lb.			PTA4541BK PTA4541GR
	½"-13 x 2" #46	Rubber	Black Gray	132 lb.			PTA4546BK PTA4546GR
5"	⅜"-16 x ¾" #37	Rubber	Black Gray	132 lb.	5½"	3 ¹⁵ / ₁₆ " 4 ³ / ₈ " [-B]	PTA5037BK PTA5037GR
	½"-13 x 1" #41	Rubber	Black Gray	132 lb.			PTA5041BK PTA5041GR
	½"-13 x 2" #46	Rubber	Black Gray	132 lb.			PTA5046BK PTA5046GR

Dimensions shown are approximate. Contact factory for specific dimensions. Other fastenings and finishes may be available. Order restrictions may apply.



Plates

Wheel Diameter	Fastening Size	Tread Material	Finish	Dynamic Load	Mounting Height	Swivel Radius	Part Number
4 1/2"	2 9/16" Square #14	Rubber	Black Gray	132 lb.	5 3/8"	3 17/32" 3 7/8" [-B]	PTA4514BK
	2 3/4" x 3 3/4" #20	Rubber	Black Gray	132 lb.			PTA4520BK
5"	2 9/16" Square #14	Rubber	Black Gray	132 lb.	5 3/4"	3 15/16" 4 3/8" [-B]	PTA5014BK
	2 3/4" x 3 3/4" #20	Rubber	Black Gray	132 lb.			PTA5020BK

For detailed plate information, see back of catalog.

Grip Ring Stems

Wheel Diameter	Fastening Size	Tread Material	Finish	Dynamic Load	Mounting Height	Swivel Radius	Part Number
4 1/2"	7/16" x 1 7/8" #42 Grip Ring	Rubber	Black Gray	132 lb.	5 1/8"	3 17/32" 3 7/8" [-B]	PTA4542BK PTA4542GR
5"	7/16" x 1 7/8" #42 Grip Ring	Rubber	Black Gray	132 lb.	5 1/2"	3 15/16" 4 3/8" [-B]	PTA5042BK PTA5042GR

TOTAL LOCK

Unhooded Large Twin Wheel Casters 75 mm, 100 mm, 120 mm



Available by
Special Order Only,
Minimum Order
May Apply

STANDARD FEATURES

- Total lock version locks both swivel and wheel
- Strong nylon construction with urethane tread
- Available by special order

APPLICATIONS

- Medical Equipment
- Utility Carts
- Fixtures

Threaded Stems

Wheel Diameter	Fastening Size	Tread Material	Tread Color	Dynamic Load	Mounting Height	Swivel Radius	Type	Part Number
75 mm	1/2"-13 x 1" #41	Urethane	Gray w/Black Tread	165	3 7/8"	2 1/4" 2 3/16" [-B]	Total Lock Swivel w/Brake Swivel	PYT7541GR-U PYS7541GR-BU PYS7541GR-U
100 mm	1/2"-13 x 1" #41	Urethane	Gray w/Black Tread	175	4 5/16"	3 1/16" 3 3/4" [-B]	Total Lock Swivel w/Brake Swivel	PYT10041GR-U PYS10041GR-BU PYS10041GR-U
120 mm	1/2"-13 x 1" #41	Urethane	Gray w/Black Tread	180	5 7/16"	3 9/16" 4 17/16" [-B]	Total Lock Swivel w/Brake Swivel	PYT12041GR-U PYS12041GR-BU PYS12041GR-U

Plates

Wheel Diameter	Fastening Size/(Bolt Hole)	Tread Material	Tread Color	Dynamic Load	Mounting Height	Swivel Radius	Type	Part Number
75 mm	2 5/16" x 2 3/4" (1 5/8" x 2 3/16") #126	Urethane	Gray w/Black Tread	165	3 9/16"	2 1/4" 2 3/16" [-B]	Total Lock Swivel w/Brake Swivel	PYT75126GR-U PYS75126GR-BU PYS75126GR-U
100 mm	2 5/8" x 3 3/4" (1 3/4" x 2 3/4"-3) #120	Urethane	Gray w/Black Tread	175	5 5/16"	3 1/16" 3 3/4" [-B]	Total Lock Swivel w/Brake Swivel	PYT100120GR-U PYS100120GR-BU PYS100120GR-U
120 mm	2 5/8" x 3 3/4" (1 3/4" x 2 3/4"-3) #120	Urethane	Gray w/Black Tread	180	5 3/16"	3 9/16" 4 7/16" [-B]	Total Lock Swivel w/Brake Swivel	PYT120120GR-U PYS120120GR-BU PYS120120GR-U

Dimensions shown are approximate. Contact factory for specific dimensions.
Other fastenings and finishes may be available. Order restrictions may apply.

METAL TREAD

Metal Tread Ball Casters 1½", 2", 2½"



STANDARD FEATURES

- Self-lubricating acetyl resin bearing
- No exposed axle
- Meets or exceeds ANSI/BIFMA standards for seating in the metal tread 2" and 2½" models.

APPLICATIONS

- Furniture
- Store Fixtures
- Medical Equipment
- Office Equipment

OPTIONS

BRAKE

Brake option available on 2½" model.

For brake option, insert [-B] at the end of the Part Number.



TRED-GARD®

Tred-Gard® hard plastic protective covers protect the treads of 2" and 2½" metal ball casters from scratches during manufacturing and shipping.

For Tred-Gard® option, insert [-T] at the end of the Part Number.



FINISHES

AVAILABLE FINISHES

Bright Brass [BB]
Bright Chrome [BC]
Satin Chrome [SC]
Windsor Antique [WA]

Not all caster models available in all finishes.

Stemless

Wheel Diameter	Fastening Size	Tread Material	Finish	Dynamic Load	Mounting Height	Swivel Radius	Part Number
1½" Starlet	No Fastening	Metal	Bright Brass Bright Chrome Windsor Antique	40 lb.	N/A	1¼"	PST1500BB PST1500BC PST1500WA
2" Satellite	No Fastening	Metal	Bright Brass Bright Chrome Satin Chrome Windsor Antique	75 lb.	N/A	1½"	PSE2000BB PSE2000BC PSE2000SC PSE2000WA
2½" Planet	No Fastening	Metal	Bright Brass Bright Chrome Satin Chrome Windsor Antique	100 lb.	N/A	1⅞" 2⅝" [-B]	PPL2500BB PPL2500BC PPL2500SC PPL2500WA

Dimensions shown are approximate. Contact factory for specific dimensions.
Other fastenings and finishes may be available. Order restrictions may apply.



Wheel Diameter	Fastening Size	Tread Material	Finish	Dynamic Load	Mounting Height	Swivel Radius	Part Number
1 1/2" Starlet	5/16"-18 x 1/2" #25	Metal	Bright Brass Bright Chrome Windsor Antique	40 lb.	2"	1 1/16"	PST1525BB PST1525BC PST1525WA
2" Satellite	1/4"-20 x 5/8" #28	Metal	Bright Brass Bright Chrome Satin Chrome Windsor Antique	75 lb.	2 5/16"	1 1/2"	PSE2028BB PSE2028BC PSE2028SC PSE2028WA
	5/16"-18 x 1/2" #25	Metal	Bright Brass Bright Chrome Satin Chrome Windsor Antique	75 lb.			PSE2025BB PSE2025BC PSE2025SC PSE2025WA
	5/16"-18 x 1" #07	Metal	Bright Brass Bright Chrome Satin Chrome Windsor Antique	75 lb.			PSE2007BB PSE2007BC PSE2007SC PSE2007WA
	3/8"-24 x 5/8" #39	Metal	Bright Brass Bright Chrome Satin Chrome Windsor Antique	75 lb.			PSE2039BB PSE2039BC PSE2039SC PSE2039WA
	3/8"-16 x 3/4" #37	Metal	Bright Brass Bright Chrome Satin Chrome Windsor Antique	75 lb.			PSE2037BB PSE2037BC PSE2037SC PSE2037WA
	3/8"-16 x 1 1/2" #05	Metal	Bright Brass Bright Chrome Satin Chrome Windsor Antique	75 lb.			PSE2005BB PSE2005BC PSE2005SC PSE2005WA
	2 1/2" Planet	5/16"-18 x 1/2" #25	Metal	Bright Brass Bright Chrome Satin Chrome Windsor Antique			100 lb.
5/16"-18 x 7/8" #45		Metal	Bright Brass Bright Chrome Satin Chrome Windsor Antique	100 lb.	PPL2545BB PPL2545BC PPL2545SC PPL2545WA		
5/16"-18 x 1 1/4" #26		Metal	Bright Brass Bright Chrome Satin Chrome Windsor Antique	100 lb.	PPL2526BB PPL2526BC PPL2526SC PPL2526WA		

Dimensions shown are approximate. Contact factory for specific dimensions.
Other fastenings and finishes may be available. Order restrictions may apply.

METAL TREAD



Threaded Stems

Wheel Diameter	Fastening Size	Tread Material	Finish	Dynamic Load	Mounting Height	Swivel Radius	Part Number
2 1/2" Planet	5/16"-18 x 2" #12	Metal	Bright Brass Bright Chrome Satin Chrome Windsor Antique	100 lb.	2 13/16"	1 7/8" 2 5/16" [-B]	PPL2512BB PPL2512BC PPL2512SC PPL2512WA
	3/8"-24 x 5/8" #39	Metal	Bright Brass Bright Chrome Satin Chrome Windsor Antique	100 lb.			PPL2539BB PPL2539BC PPL2539SC PPL2539WA
	3/8"-16 x 3/4" #37	Metal	Bright Brass Bright Chrome Satin Chrome Windsor Antique	100 lb.			PPL2537BB PPL2537BC PPL2537SC PPL2537WA
	3/8"-16 x 1 1/2" #05	Metal	Bright Brass Bright Chrome Satin Chrome Windsor Antique	100 lb.			PPL2505BB PPL2505BC PPL2505SC PPL2505WA



Plates

Wheel Diameter	Fastening Size	Tread Material	Finish	Dynamic Load	Mounting Height	Swivel Radius	Part Number
1 1/2" Starlet	1/16" Round #1R	Metal	Bright Brass Bright Chrome Windsor Antique	40 lb.	2"	1 1/16"	PST151RBB PST151RBC PST151RWA
2" Satellite	1 3/16" x 2" #13	Metal	Bright Brass Bright Chrome Satin Chrome Windsor Antique	75 lb.	2 1/2"	1 1/2"	PSE2013BB PSE2013BC PSE2013SC PSE2013WA
	1 1/2" Square #01	Metal	Bright Brass Bright Chrome Satin Chrome Windsor Antique	75 lb.			PSE2001BB PSE2001BC PSE2001SC PSE2001WA
2 1/2" Planet	1 3/16" x 2" #13	Metal	Bright Brass Bright Chrome Satin Chrome Windsor Antique	100 lb.	3"	1 7/8" 2 5/16" [-B]	PPL2513BB PPL2513BC PPL2513SC PPL2513WA
	1 1/2" Square #01	Metal	Bright Brass Bright Chrome Satin Chrome Windsor Antique	100 lb.			PPL2501BB PPL2501BC PPL2501SC PPL2501WA
	1 3/4" x 3" #40	Metal	Bright Brass Bright Chrome Satin Chrome Windsor Antique	100 lb.			PPL2540BB PPL2540BC PPL2540SC PPL2540WA

For detailed plate information, see back of catalog.

Dimensions shown are approximate. Contact factory for specific dimensions.
Other fastenings and finishes may be available. Order restrictions may apply.

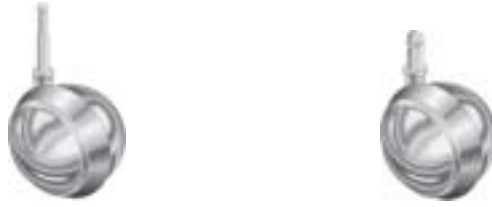

Wheel Diameter	Fastening Size	Tread Material	Finish	Dynamic Load	Mounting Height	Swivel Radius	Part Number
1½" Starlet	5/16" x 1½" #02 Grip Neck	Metal	Bright Brass Bright Chrome Windsor Antique	40 lb.	1⅞"	1⅛"	PST1502BB PST1502BC PST1502WA
2" Satellite	5/16" x 1½" #02 Grip Neck	Metal	Bright Brass Bright Chrome Satin Chrome Windsor Antique	75 lb.			PSE2002BB PSE2002BC PSE2002SC PSE2002WA
	3/8" x 1" #87 Grip Ring	Metal	Bright Brass Bright Chrome Satin Chrome Windsor Antique	75 lb.			PSE2087BB PSE2087BC PSE2087SC PSE2087WA
	3/8" x 1⅝" #4B Grip Neck	Metal	Bright Brass Bright Chrome Satin Chrome Windsor Antique	75 lb.	2⅜"	1½"	PSE204BBB PSE204BBC PSE204BSC PSE204BWA
	7/16" x 7/8" #88 Grip Ring	Metal	Bright Brass Bright Chrome Satin Chrome Windsor Antique	75 lb.			PSE2088BB PSE2088BC PSE2088SC PSE2088WA
	7/16" x 1⅞" #82 Grip Ring	Metal	Bright Brass Bright Chrome Satin Chrome Windsor Antique	75 lb.			PSE2082BB PSE2082BC PSE2082SC PSE2082WA
2½" Planet	5/16" x 1½" #02 Grip Neck	Metal	Bright Brass Bright Chrome Satin Chrome Windsor Antique	100 lb.			PPL2502BB PPL2502BC PPL2502SC PPL2502WA
	3/8" x 1" #87 Grip Ring	Metal	Bright Brass Bright Chrome Satin Chrome Windsor Antique	100 lb.			PPL2587BB PPL2587BC PPL2587SC PPL2587WA
	3/8" x 1⅝" #4B Grip Neck	Metal	Bright Brass Bright Chrome Satin Chrome Windsor Antique	100 lb.	2⅞"	1⅞" 2⅝" [-B]	PPL254BBB PPL254BBC PPL254BSC PPL254BWA
	7/16" x 7/8" #88 Grip Ring	Metal	Bright Brass Bright Chrome Satin Chrome Windsor Antique	100 lb.			PPL2588BB PPL2588BC PPL2588SC PPL2588WA
	7/16" x 1⅞" #82 Grip Ring	Metal	Bright Brass Bright Chrome Satin Chrome Windsor Antique	100 lb.			PPL2582BB PPL2582BC PPL2582SC PPL2582WA

Dimensions shown are approximate. Contact factory for specific dimensions.
Other fastenings and finishes may be available. Order restrictions may apply.

SOFT TREAD

Soft Tread Ball Casters 1⁹/₁₆", 2¹/₄", 3"

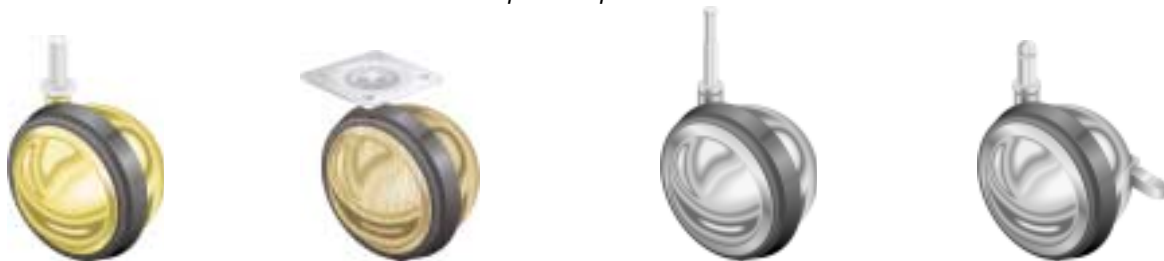

STANDARD FEATURES

- Self-lubricating acetyl resin bearing
- No exposed axle

APPLICATIONS

- Furniture
- Store Fixtures
- Medical Equipment
- Office Equipment

OPTIONS

BRAKE

Brake option available on 3" models only.

For brake option, insert [-B] at the end of the Part Number.



LOCKING PIN CASTER

Locking pin model (NL30) available on 3" soft tread unfinished caster only. Brake option not available.

For locking pin option, use NL30 in place of SN30 in the Part Number.



FINISHES

AVAILABLE FINISHES

Bright Brass [BB]
Bright Chrome [BC]
Satin Chrome [SC]
Windsor Antique [WA]

Not all caster models available in all finishes.

Stemless

Wheel Diameter	Fastening Size	Tread Material	Finish	Dynamic Load	Mounting Height	Swivel Radius	Part Number
1⁹/₁₆" Cosmo	No Fastening	Urethane	Bright Brass	40 lb.	N/A	1 ¹ / ₄ "	PCM4000BB
2¹/₄" Nova	No Fastening	Rubber	Bright Brass Bright Chrome Satin Chrome Unfinished Windsor Antique	75 lb.	N/A	1 ¹ / ₂ "	PNA2200BB PNA2200BC PNA2200SC PNA2200UF PNA2200WA
3" Saturn	No Fastening	Rubber	Bright Brass Bright Chrome Satin Chrome Unfinished Windsor Antique	100 lb.	N/A	1 ⁷ / ₈ " 2 ⁵ / ₁₆ " [-B]	PSN3000BB PSN3000BC PSN3000SC PSN3000UF PSN3000WA

Dimensions shown are approximate. Contact factory for specific dimensions. Other fastenings and finishes may be available. Order restrictions may apply.



Wheel Diameter	Fastening Size	Tread Material	Finish	Dynamic Load	Mounting Height	Swivel Radius	Part Number
1⁹/₁₆" Cosmo	⁵ / ₁₆ "-18 x ¹ / ₂ " #25	Urethane	Bright Brass	40 lb.	1 ¹³ / ₁₆ "	1 ¹ / ₁₆ "	PCM4025BB
2¹/₄" Nova	¹ / ₄ "-20 x ⁵ / ₈ " #28	Rubber	Bright Brass Bright Chrome Satin Chrome Unfinished Windsor Antique	75 lb.	2 ⁷ / ₁₆ "	1 ⁹ / ₁₆ "	PNA2228BB PNA2228BC PNA2228SC PNA2228UF PNA2228WA
	⁵ / ₁₆ "-18 x ¹ / ₂ " #25	Rubber	Bright Brass Bright Chrome Satin Chrome Unfinished Windsor Antique	75 lb.			PNA2225BB PNA2225BC PNA2225SC PNA2225UF PNA2225WA
	⁵ / ₁₆ "-18 x 1" #07	Rubber	Bright Brass Bright Chrome Satin Chrome Unfinished Windsor Antique	75 lb.			PNA2207BB PNA2207BC PNA2207SC PNA2207UF PNA2207WA
	³ / ₈ "-24 x ⁵ / ₈ " #39	Rubber	Bright Brass Bright Chrome Satin Chrome Unfinished Windsor Antique	75 lb.			PNA2239BB PNA2239BC PNA2239SC PNA2239UF PNA2239WA
	³ / ₈ "-16 x ³ / ₄ " #37	Rubber	Bright Brass Bright Chrome Satin Chrome Unfinished Windsor Antique	75 lb.			PNA2237BB PNA2237BC PNA2237SC PNA2237UF PNA2237WA
	³ / ₈ "-16 x 1 ¹ / ₂ " #05	Rubber	Bright Brass Bright Chrome Satin Chrome Unfinished Windsor Antique	75 lb.			PNA2205BB PNA2205BC PNA2205SC PNA2205UF PNA2205WA

Dimensions shown are approximate. Contact factory for specific dimensions.
Other fastenings and finishes may be available. Order restrictions may apply.



Wheel Diameter	Fastening Size	Tread Material	Finish	Dynamic Load	Mounting Height	Swivel Radius	Part Number
3" Saturn	$\frac{5}{16}$ "-18 x $\frac{1}{2}$ " #25	Rubber	Bright Brass Bright Chrome Satin Chrome Unfinished Windsor Antique	90 lb.			PSN3025BB PSN3025BC PSN3025SC PSN3025UF PSN3025WA
	$\frac{5}{16}$ "-18 x $\frac{7}{8}$ " #45	Rubber	Bright Brass Bright Chrome Satin Chrome Unfinished Windsor Antique	90 lb.			PSN3045BB PSN3045BC PSN3045SC PSN3045UF PSN3045WA
	$\frac{5}{16}$ "-18 x $1\frac{1}{4}$ " #26	Rubber	Bright Brass Bright Chrome Satin Chrome Unfinished Windsor Antique	90 lb.			PSN3026BB PSN3026BC PSN3026SC PSN3026UF PSN3026WA
	$\frac{5}{16}$ "-18 x 2" #12	Rubber	Bright Brass Bright Chrome Satin Chrome Unfinished Windsor Antique	90 lb.	3"	$2\frac{1}{16}$ " $2\frac{5}{16}$ " [-B]	PSN3012BB PSN3012BC PSN3012SC PSN3012UF PSN3012WA
	$\frac{3}{8}$ "-24 x $\frac{5}{8}$ " #39	Rubber	Bright Brass Bright Chrome Satin Chrome Unfinished Windsor Antique	90 lb.			PSN3039BB PSN3039BC PSN3039SC PSN3039UF PSN3039WA
	$\frac{3}{8}$ "-16 x $\frac{3}{4}$ " #37	Rubber	Bright Brass Bright Chrome Satin Chrome Unfinished Windsor Antique	90 lb.			PSN3037BB PSN3037BC PSN3037SC PSN3037UF PSN3037WA
	$\frac{3}{8}$ "-16 x $1\frac{1}{2}$ " #05	Rubber	Bright Brass Bright Chrome Satin Chrome Unfinished Windsor Antique	90 lb.			PSN3005BB PSN3005BC PSN3005SC PSN3005UF PSN3005WA



Wheel Diameter	Fastening Size	Tread Material	Finish	Dynamic Load	Mounting Height	Swivel Radius	Part Number
1⁹/₁₆" Cosmo	1 ¹ / ₁₆ " Round #1R	Urethane	Bright Brass	40 lb.	1 ¹³ / ₁₆ "	1 ¹ / ₁₆ "	PCM401RBB
2¹/₄" Nova	1 ³ / ₁₆ " x 2" #13	Rubber	Bright Brass Bright Chrome Satin Chrome Unfinished Windsor Antique	75 lb.	2 ⁵ / ₈ "	1 ¹ / ₁₆ "	PNA2213BB PNA2213BC PNA2213SC PNA2213UF PNA2213WA
	1 ¹ / ₂ " Square #01	Rubber	Bright Brass Bright Chrome Satin Chrome Unfinished Windsor Antique	75 lb.			PNA2201BB PNA2201BC PNA2201SC PNA2201UF PNA2201WA
3" Saturn	1 ³ / ₁₆ " x 2" #13	Rubber	Bright Brass Bright Chrome Satin Chrome Unfinished Windsor Antique	90 lb.	3 ³ / ₁₆ "	2 ¹ / ₁₆ " 2 ⁵ / ₁₆ " [-B]	PSN3013BB PSN3013BC PSN3013SC PSN3013UF PSN3013WA
	1 ¹ / ₂ " Square #01	Rubber	Bright Brass Bright Chrome Satin Chrome Unfinished Windsor Antique	90 lb.			PSN3001BB PSN3001BC PSN3001SC PSN3001UF PSN3001WA
	1 ³ / ₄ " x 3" #40	Rubber	Bright Brass Bright Chrome Satin Chrome Unfinished Windsor Antique	90 lb.			PSN3040BB PSN3040BC PSN3040SC PSN3040UF PSN3040WA

For detailed plate information, see back of catalog.



Wheel Diameter	Fastening Size	Tread Material	Finish	Dynamic Load	Mounting Height	Swivel Radius	Part Number
1⁹/₁₆" Cosmo	⁵ / ₁₆ " x 1 ¹ / ₂ " #02 Grip Neck	Urethane	Bright Brass	40 lb.	1 ¹¹ / ₁₆ "	1 ¹ / ₄ "	PCM4002BB
2¹/₄" Nova	⁵ / ₁₆ " x 1 ¹ / ₂ " #02 Grip Neck	Rubber	Bright Brass Bright Chrome Satin Chrome Unfinished Windsor Antique	75 lb.	2 ⁵ / ₁₆ "	1 ¹ / ₆ "	PNA2202BB PNA2202BC PNA2202SC PNA2202UF PNA2202WA
	³ / ₈ " x 1" #87 Grip Ring	Rubber	Bright Brass Bright Chrome Satin Chrome Unfinished Windsor Antique	75 lb.			PNA2287BB PNA2287BC PNA2287SC PNA2287UF PNA2287WA
	³ / ₈ " x 1 ⁵ / ₈ " #4B Grip Neck	Rubber	Bright Brass Bright Chrome Satin Chrome Unfinished Windsor Antique	75 lb.			PNA224BBB PNA224BBC PNA224BSC PNA224BUF PNA224BWA
	⁷ / ₁₆ " x ⁷ / ₈ " #88 Grip Ring	Rubber	Bright Brass Bright Chrome Satin Chrome Unfinished Windsor Antique	75 lb.			PNA2288BB PNA2288BC PNA2288SC PNA2288UF PNA2288WA
	⁷ / ₁₆ " x 1 ⁷ / ₁₆ " #82 Grip Ring	Rubber	Bright Brass Bright Chrome Satin Chrome Unfinished Windsor Antique	75 lb.			PNA2282BB PNA2282BC PNA2282SC PNA2282UF PNA2282WA
3" Saturn	⁵ / ₁₆ " x 1 ¹ / ₂ " #02 Grip Neck	Rubber	Bright Brass Bright Chrome Satin Chrome Unfinished Windsor Antique	90 lb.	2 ⁷ / ₈ "	2 ¹ / ₆ " 2 ⁵ / ₁₆ " [-B]	PSN3002BB PSN3002BC PSN3002SC PSN3002UF PSN3002WA
	³ / ₈ " x 1" #87 Grip Ring	Rubber	Bright Brass Bright Chrome Satin Chrome Unfinished Windsor Antique	90 lb.			PSN3087BB PSN3087BC PSN3087SC PSN3087UF PSN3087WA
	³ / ₈ " x 1 ⁵ / ₈ " #4B Grip Neck	Rubber	Bright Brass Bright Chrome Satin Chrome Unfinished Windsor Antique	90 lb.			PSN304BBB PSN304BBC PSN304BSC PSN304BUF PSN304BWA
	⁷ / ₁₆ " x ⁷ / ₈ " #88 Grip Ring	Rubber	Bright Brass Bright Chrome Satin Chrome Unfinished Windsor Antique	90 lb.			PSN3088BB PSN3088BC PSN3088SC PSN3088UF PSN3088WA
	⁷ / ₁₆ " x 1 ⁷ / ₁₆ " #82 Grip Ring	Rubber	Bright Brass Bright Chrome Satin Chrome Unfinished Windsor Antique	90 lb.			PSN3082BB PSN3082BC PSN3082SC PSN3082UF PSN3082WA

Dimensions shown are approximate. Contact factory for specific dimensions.
Other fastenings and finishes may be available. Order restrictions may apply.

PROFILE

Stylish Ball Caster 2½", 3"



APPLICATIONS

- Furniture
- Store Fixtures
- Medical Equipment
- Office Equipment

STANDARD FEATURES

- Self-lubricating acetyl resin bearing
- No exposed axle
- Meets or exceeds ANSI/BIFMA standards for seating in all metal tread models

OPTION

BRAKE

Brake option available on all models.



For brake option, insert [-B] at the end of the Part Number.

Stemless

Wheel Diameter	Fastening Size	Tread Material	Finish	Dynamic Load	Mounting Height	Swivel Radius	Part Number
2½"	No Fastening	Metal	Bright Chrome Satin Chrome	100 lb.	N/A	1 ¹⁵ / ₁₆ " 2 ¹ / ₄ " [-B]	PPR2500BC PPR2500SC
	No Fastening	Rubber	Bright Chrome Satin Chrome	100 lb.	N/A	2 ¹ / ₁₆ " 2 ¹ / ₄ " [-B]	PPR3000BC PPR3000SC

Threaded Stems

Wheel Diameter	Fastening Size	Tread Material	Finish	Dynamic Load	Mounting Height	Swivel Radius	Part Number
2½"	5/16"-18 x 1/2" #25	Metal	Bright Chrome Satin Chrome	100 lb.	2 ¹³ / ₁₆ "	1 ¹⁵ / ₁₆ " 2 ¹ / ₄ " [-B]	PPR2525BC PPR2525SC
	5/16"-18 x 7/8" #45	Metal	Bright Chrome Satin Chrome	100 lb.			PPR2545BC PPR2545SC
	5/16"-18 x 1¼" #26	Metal	Bright Chrome Satin Chrome	100 lb.			PPR2526BC PPR2526SC
	5/16"-18 x 2" #12	Metal	Bright Chrome Satin Chrome	100 lb.			PPR2512BC PPR2512SC
	3/8"-24 x 5/8" #39	Metal	Bright Chrome Satin Chrome	100 lb.			PPR2539BC PPR2539SC
	3/8"-16 x 3/4" #37	Metal	Bright Chrome Satin Chrome	100 lb.			PPR2537BC PPR2537SC
	3/8"-16 x 1½" #05	Metal	Bright Chrome Satin Chrome	100 lb.			PPR2505BC PPR2505SC
3"	5/16"-18 x 1/2" #25	Rubber	Bright Chrome Satin Chrome	100 lb.	2 ¹⁵ / ₁₆ "	2 ¹ / ₁₆ " 2 ¹ / ₄ " [-B]	PPR3025BC PPR3025SC
	5/16"-18 x 7/8" #45	Rubber	Bright Chrome Satin Chrome	100 lb.			PPR3045BC PPR3045SC
	5/16"-18 x 1¼" #26	Rubber	Bright Chrome Satin Chrome	100 lb.			PPR3026BC PPR3026SC
	5/16"-18 x 2" #12	Rubber	Bright Chrome Satin Chrome	100 lb.			PPR3012BC PPR3012SC
	3/8"-24 x 5/8" #39	Rubber	Bright Chrome Satin Chrome	100 lb.			PPR3039BC PPR3039SC
	3/8"-16 x 3/4" #37	Rubber	Bright Chrome Satin Chrome	100 lb.			PPR3037BC PPR3037SC
	3/8"-16 x 1½" #05	Rubber	Bright Chrome Satin Chrome	100 lb.			PPR3005BC PPR3005SC

Dimensions shown are approximate. Contact factory for specific dimensions.
Other fastenings and finishes may be available. Order restrictions may apply.

Plates

Wheel Diameter	Fastening Size	Tread Material	Finish	Dynamic Load	Mounting Height	Swivel Radius	Part Number
2½"	1⅜" x 2" #13	Metal	Bright Chrome Satin Chrome	100 lb.	3"	1⅝" 2¼" [-B]	PPR2513BC PPR2513SC
	1½" Square #01	Metal	Bright Chrome Satin Chrome	100 lb.			PPR2501BC PPR2501SC
3"	1⅜" x 2" #13	Rubber	Bright Chrome Satin Chrome	100 lb.	3⅞"	2⅞" 2¼" [-B]	PPR3013BC PPR3013SC
	1½" Square #01	Rubber	Bright Chrome Satin Chrome	100 lb.			PPR3001BC PPR3001SC

For detailed plate information, see back of catalog.

Grip Neck and Grip Ring Stems

Wheel Diameter	Fastening Size	Tread Material	Finish	Dynamic Load	Mounting Height	Swivel Radius	Part Number
2½"	⅝" x 1½" #02 Grip Neck	Metal	Bright Chrome Satin Chrome	100 lb.	2⅞"	1⅝" 2¼" [-B]	PPR2502BC PPR2502SC
	⅜" x 1" #87 Grip Ring	Metal	Bright Chrome Satin Chrome	100 lb.			PPR2587BC PPR2587SC
	⅞" x ⅞" #88 Grip Ring	Metal	Bright Chrome Satin Chrome	100 lb.			PPR2588BC PPR2588SC
	⅞" x 1⅞" #82 Grip Ring	Metal	Bright Chrome Satin Chrome	100 lb.			PPR2582BC PPR2582SC
3"	⅝" x 1½" #02 Grip Neck	Rubber	Bright Chrome Satin Chrome	100 lb.	2⅞"	2⅞" 2¼" [-B]	PPR3002BC PPR3002SC
	⅜" x 1" #87 Grip Ring	Rubber	Bright Chrome Satin Chrome	100 lb.			PPR3087BC PPR3087SC
	⅞" x ⅞" #88 Grip Ring	Rubber	Bright Chrome Satin Chrome	100 lb.			PPR3088BC PPR3088SC
	⅞" x 1⅞" #82 Grip Ring	Rubber	Bright Chrome Satin Chrome	100 lb.			PPR3082BC PPR3082SC

Dimensions shown are approximate. Contact factory for specific dimensions.
Other fastenings and finishes may be available. Order restrictions may apply.

WHEELS

MONOTECH



PN 007320

- Constructed of a special mix of monoprene that rejects almost every type of floor debris
- Soft durometer allows maximum shock absorption and cushions ride to protect your equipment, cargo, and floors while reducing noise
- Resistant to most chemicals and oils
- Round tread offers better mobility
- Available with gray tread chemically bonded to marble gray core
- Nylon bearings standard

Wheel Size	Part Number	Tread Width	Hub Length	Axle Size	Color (Tread/Core)	Dynamic Load	Durometer/Shore Scale
3"	009001	1 ⁵ / ₁₆ "	1.01"	1/4"	Gray/Gray	120 lb.	65A
4"	009003	1"	1.18"	5/16"	Gray/Gray	150 lb.	65A
5"	007315	1"	1.18"	5/16"	Gray/Gray	160 lb.	65A
5**	007312	1"	1.18"	5/16"	Gray/Gray	160 lb.	65A

*1 Precision Bearing with full thread guards version is also available in 5" only.

THERMOPLASTIC RUBBER (TPR)



- Thermoplastic rubber tread offers resistance to oils and chemicals
- Great alternative to standard rubber wheels
- Mechanically interlocked tread eliminates separation

Wheel Size	Part Number	Tread Width	Hub Length	Axle Size	Dynamic Load	Durometer/Shore Scale
2"	007962	1 ³ / ₁₆ "	.90"	1/4"	80 lb.	40D
2 ¹ / ₂ "	007964	1 ³ / ₁₆ "	.90"	1/4"	90 lb.	40D
3"	007966	1 ³ / ₁₆ "	1.00"	1/4"	110 lb.	40D
4"	007273	1 ⁵ / ₁₆ "	1.15"	5/16"	125 lb.	75A
5"	007313	1"	1.15"	5/16"	130 lb.	75A

POLYURETHANE (TPU)



- High-grade polyurethane tread for extended wear
- Protects floors and resists oils and chemicals
- Mechanically interlocked tread eliminates separation

Wheel Size	Part Number	Tread Width	Hub Length	Axle Size	Dynamic Load	Durometer/Shore Scale
2"	007963	1 ³ / ₁₆ "	.90"	1/4"	100 lb.	40D
2 ¹ / ₂ "	007965	1 ³ / ₁₆ "	.90"	1/4"	120 lb.	40D
3"	007967	1 ³ / ₁₆ "	1.00"	1/4"	125 lb.	40D
4"	007274	1 ⁵ / ₁₆ "	1.15"	5/16"	150 lb.	40D
5"	007314	1"	1.15"	5/16"	150 lb.	40D

SOFT RUBBER



- Offers quiet mobility on hard surfaces
- Combines a cushioned ride with maximum floor protection
- Nylon bushing for better rollability
- Non-marking

Wheel Size	Part Number	Tread Width	Hub Length	Axle Size	Dynamic Load	Durometer/Shore Scale
1 ⁵ / ₈ "	006371	2 ³ / ₃₂ "	.77"	7/32"	70 lb.	75A
2"	006102	1 ³ / ₁₆ "	.92"	1/4"	80 lb.	75A
2 ¹ / ₂ "	006742	1 ³ / ₁₆ "	.92"	1/4"	90 lb.	75A
3"	007385	1 ³ / ₁₆ "	.99"	1/4"	110 lb.	75A
4"	007272	1 ⁵ / ₁₆ "	1.15"	5/16"	125 lb.	75A
5"	007312	1 ⁵ / ₁₆ "	1.15"	5/16"	130 lb.	75A

Dimensions shown are approximate. Contact factory for specific dimensions. Other fastenings and finishes may be available. Order restrictions may apply.

HARD RUBBER



- High load rating and impact resistance
- Good mobility
- Nylon bushing for better rollability
- Non-marking

Wheel Size	Part Number	Tread Width	Hub Length	Axle Size	Dynamic Load	Durometer/ Shore Scale
2"	006646	1 ³ / ₁₆ "	.92"	1/4"	100 lb.	80D
2 1/2"	006744	1 ³ / ₁₆ "	.92"	1/4"	110 lb.	80D
3"	007380	1 ³ / ₁₆ "	.99"	1/4"	120 lb.	80D
4"	007271	1 ⁵ / ₁₆ "	1.15"	5/16"	150 lb.	80D
5"	007311	1 ⁵ / ₁₆ "	1.15"	5/16"	150 lb.	80D

POLYOLEFIN



- High-impact strength, lightweight construction
- Most economical wheel option
- Plain bore
- Resistant to most chemical and oils

Wheel Size	Part Number	Tread Width	Hub Length	Axle Size	Dynamic Load	Durometer/ Shore Scale
1 1/4"	007114	1 ⁷ / ₃₂ "	.63"	3/16"	75 lb.	70D
1 5/8"	006971	1 ¹ / ₁₆ "	.77"	7/32"	80 lb.	70D
2"	006972	3/4"	.90"	1/4"	100 lb.	70D
2 1/2"	007213	1 ³ / ₁₆ "	.92"	1/4"	120 lb.	70D
3"	007386	1 ³ / ₁₆ "	.99"	1/4"	125 lb.	70D
4"	007270	1 ⁵ / ₁₆ "	1.15"	5/16"	150 lb.	70D
5"	007310	1 ⁵ / ₁₆ "	1.15"	5/16"	150 lb.	70D

SOLID POLYOLEFIN



Wheel Size	Part Number	Tread Width	Hub Length	Axle Size	Dynamic Load	Durometer/ Shore Scale
2"	007956	3/4"	.90"	1/4"	100 lb.	70D

SPHERICAL



- Solid, spherical construction
- Efficient mobility

Wheel Size	Part Number	Tread Width	Hub Length	Axle Size	Dynamic Load	Durometer/ Shore Scale
1 5/8"	006522	Soft Rubber	1.52"	7/32"	75 lb.	75A
2"	006520	Polyolefin	1.98"	1/4"	100 lb.	70D

Dimensions shown are approximate. Contact factory for specific dimensions. Other fastenings and finishes may be available. Order restrictions may apply.

INSTITUTIONAL SERIES WHEELS

POLYURETHANE (TPU)



- Polyurethane tread for extended wear
- Protects floors and resists oils and chemicals
- Mechanically bonded tread eliminates separation
- Ball bearing centers
- Available in gray or blue tread on gray core
- Plastic thread guards standard on 4" and 5" models with ball bearing centers

Wheel Diameter	Part Number	Tread Width	Bearing Type	Hub Length	Axle Size	Color (Tread/Core)	Color (Thread Guard)	Dynamic Load	Durometer/Shore Scale
3"	009101	1 1/4"	Ball	1 5/8"	3/8"	Gray/Gray	N/A	185 lb.	45D
	009102	1 1/4"	Ball	1 5/8"	3/8"	Blue/Gray	N/A	185 lb.	45D
4"	009105	1 1/4"	Ball	1 5/8"	3/8"	Gray/Gray	Gray	200 lb.	45D
	009106	1 1/4"	Ball	1 5/8"	3/8"	Blue/Gray	Black	200 lb.	45D
5"	009109	1 1/4"	Ball	1 5/8"	3/8"	Gray/Gray	Gray	225 lb.	45D
	009110	1 1/4"	Ball	1 5/8"	3/8"	Blue/Gray	Black	225 lb.	45D

THERMOPLASTIC RUBBER (TPR)



- Thermoplastic rubber tread offers resistance to oils and chemicals
- Soft durometer offers quiet mobility
- Mechanically bonded tread eliminates separation and is very durable
- Ball bearing or nylon centers
- Available in gray tread on gray core
- Plastic thread guards standard on 4" and 5" models with ball bearings

Wheel Diameter	Part Number	Tread Width	Bearing Type	Hub Length	Axle Size	Color (Tread/Core)	Color (Thread Guard)	Dynamic Load	Durometer/Shore Scale
3"	009104	1 1/4"	Ball	1 5/8"	3/8"	Gray/Gray	N/A	165 lb.	85A
	009014	1 1/4"	Nylon	1 1/2"	3/8"	Gray/Gray	N/A	165 lb.	85A
4"	009108	1 1/4"	Ball	1 5/8"	3/8"	Gray/Gray	Gray	185 lb.	85A
	009018	1 1/4"	Nylon	1 1/2"	3/8"	Gray/Gray	N/A	185 lb.	85A
5"	009112	1 1/4"	Ball	1 5/8"	3/8"	Gray/Gray	Gray	200 lb.	85A
	009022	1 1/4"	Nylon	1 1/2"	3/8"	Gray/Gray	N/A	200 lb.	85A

SOCKETS



002719



505069

Wood Sockets						
Socket Number	Material	Hole Required	Tack Plate	Attachment	Compatible Fastenings	Part Number
SR2402ZN-M36	Metal	3/8" x 1 5/8"	3/4" Dia.	Wood Press	#02 Grip Neck	002719
S66Z-B	Metal	9/16" x 1 1/2"	2 1/8" Dia.	1/4" screws	11,23,73,82,88,91	505069



Light-Duty Round Tube Sockets						
Socket Number	Material/Color	Tubing Gauge	Socket OD	Tube ID	Compatible Fastenings	Part Number
PSR0916BR-PE (5/16)	Plastic/Brown	9/16", 16 Ga.	0.450	.433 Dia.	#02 Grip Neck	003027
PSR1016WH-PE (5/16)	Plastic/White	5/8", 16 Ga.	0.513	.495 Dia.	#02 Grip Neck	002486
PSR1216WH-PE (5/16)	Plastic/White	3/4", 16 Ga.	0.637	.620 Dia.	#02 Grip Neck	002489
PSR1218WH-PE (5/16)	Plastic/White	3/4", 18 Ga.	0.667	.652 Dia.	#02 Grip Neck	002488
PSR1416WH-PE (5/16)	Plastic/White	7/8", 16 Ga.	0.765	.745 Dia.	#02 Grip Neck	002491
PSR1616WH-PE (5/16)	Plastic/White	1", 16 Ga.	0.887	.870 Dia.	#02 Grip Neck	002495
PSR1720WH-PE (5/16)	Plastic/White	1 1/16", 20 Ga.	1.002	.992 Dia.	#02 Grip Neck	002498
PSR1016BR-PE (3/8)	Plastic/Brown	5/8", 16 Ga.	0.515	.495 Dia.	#04 Grip Neck	003444
PSR1016WH-PE (3/8)	Plastic/White	5/8", 16 Ga.	0.514	.495 Dia.	#04 Grip Neck	005518



Heavy-Duty Round Tube Sockets						
PSR1616BK-PE (7/16)	Polyethylene/Black	1", 16 Ga.	0.894	.870 Dia.	#88, 82, 91 Grip Rings #73 Brass Band	002460
PSR1618BK-PE (7/16)	Polyethylene/Black	1", 18 Ga.	0.924	.902 Dia.	#88, 82, 91 Grip Rings #73 Brass Band	002473



Square Tube Sockets						
Socket Number	Material/Color	Tubing Gauge	Socket OD	Tube ID	Compatible Fastenings	Part Number
PSS1220WH-PE (5/16)	Plastic/White	3/4", 20 Ga.	0.695	.678 Sq.	#02 Grip Neck	002500
PSS1616WH-PE (5/16)	Plastic/White	1", 16 Ga.	0.890	.880 Sq.	#02 Grip Neck	002492



Metal Corner Brackets						
Socket Number	Material	Overall Height	Hole Dia.	Compatible Fastenings	Part Number	
90° w/1 1/32" Holes and Tabs	Unplated Steel	1 1/2"	1 1/32"	#88, 82, 91 Grip Rings #73 Brass Band	003313-20	
180° w/1 1/32" Holes and Tabs	Unplated Steel	1 1/2"	1 1/32"	#88, 82, 91 Grip Rings #73 Brass Band	003312-20	



Metal Tee Nut			
Socket Number	Hole Required	Compatible Fastenings	Part Number
Nut SBW33	3/8"	#25, 32, 45, 07 Threaded	002348

GLIDES

Furniture Glide – Nail-On, Threaded

- Model CG0875TH
Part No. 005164
1/4" – 20 x 1/2" Long
Rubber Cushion
Nickel Base
7/8" Dia.



- Model CG07NI
Part No. 002408
Rubber Cushion
Nickel Base
7/8" Dia.



Furniture Glide – Tack-On

- Model TG0700
Part No. 002502
White Plastic Base
7/8" Dia.



Bed Glide

- Model BG2204BB
Part No. 002357
3/8" Dia. Stem

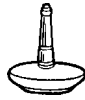

Furniture Glides – Dome

- Model PG06PN
Part No. 004902
Nickel Plated
3/4" Dia.
- Model PG07PN
Part No. 004903
Nickel Plated
7/8" Dia.

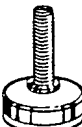

Leveling Furniture Glides – Phenolic Base					
	Glide Number	Part Number	Base Diameter	Stem Dimensions	Stem Type
	GB3	002332	1 1/4"	5/16"-18 x 1 1/2"	Rigid
	GB4	002333	1 1/2"	5/16"-18 x 1 1/2"	Rigid
	GB5	002336	1 7/8"	3/8"-16 x 1 7/8"	Rigid

Leveling Furniture Glides – Maxim				
	Part Number	Base Diameter	Cushion Material	Stem Dimensions
	002360	1 3/8"	PVC	1/4"-20 x 1"
	002361	1 3/8"	Polyethylene	5/16"-18 x 1"
	002363	1 3/8"	Polyethylene	5/16"-18 x 1 1/2"
	002365	1 3/8"	Polyethylene	5/16"-18 x 2"
	002366	1 3/8"	Polyethylene	3/8"-16 x 1"
	002369	1 3/8"	Polyethylene	3/8"-16 x 1 1/2"
	002370	1 3/8"	Polyethylene	3/8"-16 x 3 1/2"
	002372	1 3/4"	Polyethylene	1/4"-20 x 1"
	002374	1 3/4"	Polyethylene	5/16"-18 x 1"
	002377	1 3/4"	PVC	3/8"-16 x 1 1/2"
	002378	1 3/4"	Polyethylene	3/8"-16 x 1 1/2"

All Maxim glides have a hex nut at base of stem.

ACCESSORIES

Appliance Caster

- Model PAC1274ZN-2E
Part No. 98504
5/16" x 18 Thread
7/8" Long



Bed Roller

- Model OBR2204WH
Part No. 006719
3/8" Dia. Stem



Floor Protectors – Felt

- Model FP0875BN
Part No. 007117
7/8" Dia.
- Model FP1000BN
Part No. 007118
1" Dia.

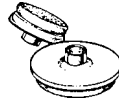

Bumpers

- Model SB07WH
Part No. 003778
Screw-On,
7/8" Dia. Cushion
White
- Screw for Bumper
SB07WH
Part No. 003857



Super Tri-Dollies

- Model PSD1300FB
Part No. 97270
6" Dia. Base
200 Lb. Rating
1 1/2" Polyolefin Wheels
- Model PSD2000FB
Part No. 98282
12" Dia. Base
300 Lb. Rating
2" Polyolefin Wheels





Lazy Susan Turntable – Ball Bearing Movement

- Model LS1200ZN
Part No. 003224
12" Dia.
1000 Lb. Rating

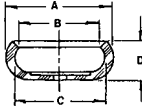

Furniture Glide Retread Caps					
	Part Number	Cap Dimension Tolerances			
		A	B	C	D
	004628	.860/.870	.645/.655	.750/.760	.325/.335
	004632	1.120/1.130	.920/.930	1.019/1.029	.365/.375
	004634	1.265/1.275	.995/1.010	1.105/1.115	.365/.375
	004636	1.360/1.375	1.130/1.145	1.190/1.205	.345/.390
	004637	1.357/1.375	1.158/1.180	1.245/1.255	.375/.390
	004638	1.360/1.370	1.160/1.170	1.260/1.270	.375/.385
	004641	1.480/1.490	1.255/1.265	1.375/1.385	.415/.425
	004643	1.660/1.670	1.450/1.460	1.560/1.570	.420/.430



Furniture Leg Tips						
	Tip Number	Part Number	Tip Dimensions			
	Black		A	B	C	D
	RUBBER					
	RT03BK	003793	3/8"	1 1/16"	7/8"	1 5/16"
	RT04BK	003792	1/2"	1 3/16"	1"	1 1/16"
	RT05BK	003791	5/8"	7/8"	1 1/16"	1 1/8"
	RT06BK	003790	3/4"	1 5/16"	1 1/4"	1 3/16"
	RT07BK	003789	7/8"	1 1/16"	1 5/16"	1 3/8"
	RT08BK	003788	1"	1 1/4"	1 1/2"	1 7/16"
	RT09BK	003787	1 1/8"	1 1/4"	1 5/8"	1 7/16"
	RT10BK	003802	1 1/4"	1 13/32"	1 13/16"	1 3/4"

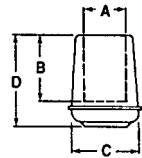

Institutional and Regent Series Threaded Stem Washer Wrench

Part Number	Description
009499	Wrench RE GS GT ZN

Used to hold caster in place while assembling to unit



44
1/4" dia.
UNF20 x 1/2"

28
1/4" dia.
UNF20 x 5/8"

25
5/16" dia.
UNC18 x 1/2"

32
5/16" dia.
UNC18 x 3/4"

45
5/16" dia.
UNC18 x 7/8"

07
5/16" dia.
UNC18 x 1"

26
5/16" dia.
UNC18 x 1 1/4"

500
5/16" dia.
UNC18 x 1 1/2"

12
5/16" dia.
UNC18 x 2"

Selecting a Fastening

Match fastening to corresponding illustration. Replacement grip ring stems can be slightly shorter than original stem and still be suitable. A rounded or squared stem head has no effect on fit.

All fastenings shown actual size.

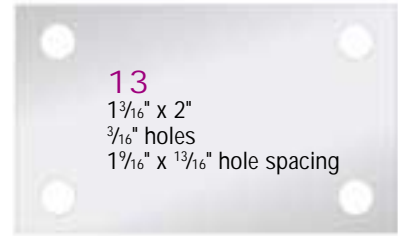
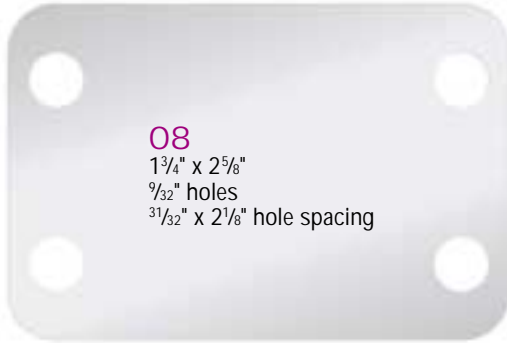

19
7/16" dia.
x 1 7/8"

42
7/16" dia.
x 1 7/8"

11-WC*
82-BC*
7/16" dia. x 1 7/16"

91
7/16" dia.
x 1 1/4"

* WC = Available on Wheel Casters only
* BC = Available on Ball & Twin Wheel Casters

23-WC*
88-BC*
7/16" dia. x 7/8"

22-WC*
87-BC*
3/8" dia. x 1"

39
3/8" dia.
UNF24 x 5/8"

35
3/8" dia.
UNC16 x 1/2"

37
3/8" dia.
UNC16 x 3/4"

34
3/8" dia.
UNC16 x 1"

05
3/8" dia.
UNC16 x 1 1/2"

800
7/16" dia.
UNC14 x 1 1/2"

41
1/2" dia.
UNC13 x 1"

48
1/2" dia.
UNC13 x 1 1/2"

46
1/2" dia.
UNC13 x 2"

806
7/16" dia.
UNC14 x 2 1/4"

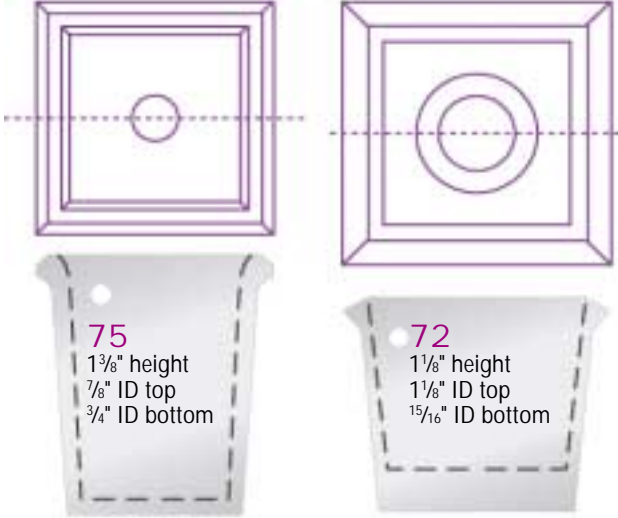

Please Note
Not all fastenings
are available with
all caster models.

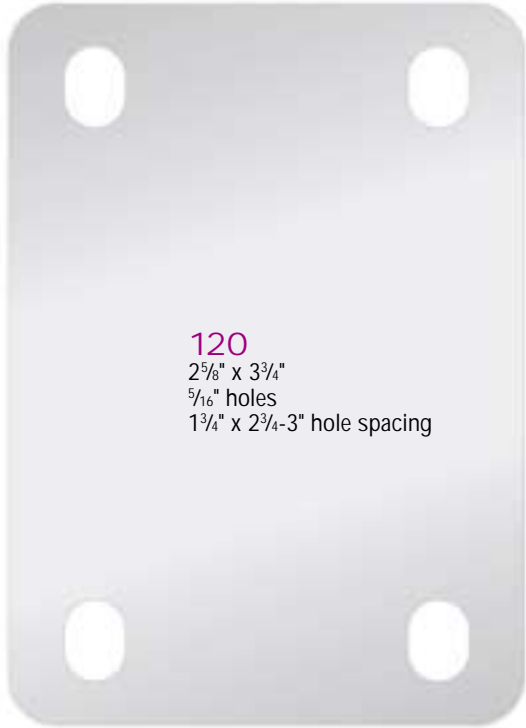

02
5/16" dia.
x 1 1/2"

4B
3/8" dia.
x 1 5/8"

70
7/16" dia.
x 1 7/16"

73
7/16" dia.
x 1 7/16" brass band

204
7/16" dia. x 2"
brass band